

# Design on Stage

Modernity in all its coherence, built on research and formal harmony with close attention to detail and consistent materials and finishes: this is B&B Italia's new collection as presented at the Milan 2019 Salone del Mobile.

Just like in the timeless telling of a story that knows no bounds, innovations appear alongside re-editions of what have (now) for some time been considered international classics.

The concept is clear and each element plays a carefully-defined role that brings out its inherent qualities with the utmost naturalness; it is in these shades of character, personality and language that the overall project finds its uniqueness and exceptionality.

Una chiara idea di modernità, fatta di ricerca, armonia formale, cura del dettaglio, coerenza tra materiali e finiture: è la nuova collezione B&B Italia.

Come nel flusso di un racconto senza tempo né confini, alle nuove creazioni si affiancano riedizioni di pezzi di design considerati dei classici internazionali.

Un concept preciso, in cui ogni soggetto occupa con naturalezza un ruolo definito, che consente di esprimere le proprie peculiarità: perché sono le differenze di carattere, personalità e linguaggio a rendere unico e straordinario il progetto generale.



After spending  
some time on Dock,  
you can leave the port  
and set sail for  
unfamiliar places,  
rested, and refreshed.

Dopo aver trascorso un po' di tempo su Dock,  
si potrà lasciare il porto e salpare verso nuovi approdi,  
riposati e ricaricati.











The new upholstered Dock seat system by Piero Lissoni is a safe haven in the home. The Dock's shape is based around a solid platform which supports the eclectic compositions that span horizontally. The platform is a dynamic element, which extends for the sofa's entire length to form a base. The narrower armrest is available in two depth sizes and is generously padded like the backrest. The cushions play with sizes and proportions, making it possible to create double-sided, corner and chaise longue compositions, with or without backrests which are suitable for the centre of the room or more traditional settings. The armrests and seat cushions have elegant tone-on-tone stitching.

Il nuovo sistema di imbottiti Dock di Piero Lissoni si presenta come un approdo sicuro nel panorama domestico. Il pianale è la piattaforma attorno alla quale prende forma Dock. La sua forte presenza materica sottolinea con decisione la vocazione orizzontale di questo eclettico sistema. Il pianale diventa un elemento dinamico, poiché si allunga ai lati per formare un piano d'appoggio. Il bracciolo è sottile, con due profondità, generosamente imbottito così come lo schienale. Anche i cuscini giocano con dimensioni e proporzioni, rendendo possibile la creazione di composizioni bifacciali, angolari, chaise-longue, con o senza schienale, adatte al centro stanza ma anche a soluzioni più tradizionali. I cuscini bracciolo e i cuscini seduta presentano una elegante cucitura con profilo tono su tono.

page / pagina 5:  
**Dock**  
sofa / divano

pages / pagine 6-7:  
**Dock**  
modular sofa, service elements  
and small table /  
divano componibile, elementi di servizio  
e tavolino  
**Jack**  
modular bookcase / libreria modulare  
**Up1**  
armchair / poltrona  
**Riso**  
carpet / tappeto

pages / pagine 8-9:  
**Dock**  
modular sofa, service elements,  
bench and small table /  
divano componibile, elementi di servizio,  
tavolino e panca













Dock can also be developed vertically and is equipped with accessories that allow for a varied landscape to be created. It is in fact possible to insert extra elements between the seat cushions such as padded or lacquered and wooden armrests. On the platform elegant service elements can be placed. They are available with oval or round top in glass, wood or lacquered. These supporting elements for the body and objects provide further choices, for a visual rhythm which gives additional possibilities to experience and conceive the system. The Dock system is accompanied by a series of complementary elements. A large low table in two sizes becomes a generously sized platform. Rectangular or square, it has the same design and finish as the sofa base canaletto walnut, light grey, black and smoked oak.

Dock si sviluppa anche in verticale ed è dotato di accessori che permettono di creare un panorama variegato. Tra i cuscini della seduta si possono infatti inserire elementi extra quali confortevoli braccioli imbottiti oppure laccati o in essenza. Sul pianale è possibile prevedere l'inserimento di eleganti tavolini con piano ovale o tondo in vetro, legno o laccato. Questi elementi di appoggio per il corpo e per gli oggetti sono in grado di garantire ancora maggiore scelta, in un ritmo visivo che offre ulteriori possibilità di vivere e concepire il sistema. Il sistema Dock nasce accompagnato da una serie di elementi complementari, che ne arricchiscono la natura enciclopedica. Un ampio tavolo basso in due formati diventa una piattaforma di dimensioni generose. Rettangolare oppure quadrato, si presenta con l'identico disegno e la medesima finitura della base del divano, ovvero noce canaletto, rovere chiaro, rovere grigio, rovere nero e rovere fumigato.



pages / pagine 12-13:

**Dock**  
sofa and service element /  
divano ed elemento di servizio  
**Riso**  
carpet / tappeto

pages / pagine 14-15:

**Dock**  
modular sofa, service element and small table /  
divano componibile, elemento di servizio e tavolino  
**Jack**  
modular bookcase / libreria modulare  
**Pablo**  
armchair / poltrona  
**Riso**  
carpet / tappeto

page / pagina 17:

**Dock**  
modular sofa and service element /  
divano componibile ed elemento di servizio









The comfortable soft padding creates a peaceful harbour, which can be further defined by the possibility to select from different depths and heights. Three depths that can be combined with a 41 cm seat height, or with a lower 27 cm version which is almost ground level to create a far-Eastern inspired composition. After spending some time on Dock, you can leave the port and set sail for unfamiliar places, rested, and refreshed.

La comodità delle soffici imbottiture crea un porto tranquillo, il cui carattere può essere ulteriormente definito dalla scelta delle profondità e delle altezze. Infatti, le tre profondità possono essere combinate con un'altezza della seduta da 41 cm, ma si può scegliere anche una versione da 27 cm, quasi rasoterra, per accomodarsi all'orientale. Dopo aver trascorso un po' di tempo su Dock, si potrà lasciare il porto e salpare verso nuovi approdi, riposati e ricaricati.



pages / pagine 20-21:  
**Dock**  
modular sofa and service element /  
divano componibile ed elemento di servizio  
**Up1**  
armchairs / poltrone  
**Spool**  
small table / tavolino  
**Riso**  
carpet / tappeto

opposite page / accanto:  
**Dock**  
modular sofa and service element /  
divano componibile ed elemento di servizio

pages / pagine 24-25:  
**Dock**  
sofa and bench / divano e panca  
**Pablo**  
armchair / poltrona  
**Spool**  
small tables / tavolini  
**Pab**  
storage system  
**Milos**  
carpet / tappeto











Spool is a small table in printed and painted rigid polyurethane with a glossy finish which is available in 18 colours. With its recognisable shape and strong tones, Spool is a lively punctuation that celebrates and enhances the eclectic nature of the Dock system.

Spool è un tavolino in poliuretano rigido stampato e verniciato con finitura lucida, disponibile in una gamma di ben 18 colori. Con la sua forma riconoscibile e i toni pieni di carattere, la presenza di Spool diventa una punteggiatura vivace che celebra ed esalta l'eclettismo dell'intero sistema Dock.



page / pagina 27:  
**Dock**  
sofa / divano  
**Spool**  
small table / tavolino  
**Milos**  
carpet / tappeto

opposite page / accanto:  
**Spool**  
small tables / tavolini

Like a suspended bridge or a flying carpet, this gentle object conceives a new visual and perceptive balance which is elegant and comfortable.



Come un ponte sospeso o un tappeto volante, questo oggetto garbato concepisce un nuovo equilibrio visivo e percettivo, tanto elegante quanto confortevole.





The B&B Italia 2019 collection introduces Pablo, a new seat by Vincent Van Duysen. Its strengths are comfort and firmness, which combine to form high-impact aesthetic and structural solutions. Pablo has a double thick leather layer with light seat padding which is barely visible but capable of ensuring comfort. The appealing shape is defined by an accentuated depth and a slightly inclined front: Pablo suggests new proportions, calibrated to the millimetre, which make this seat an innovative meeting point between small armchair and chaise longue. The structure wraps around the body and is suspended. It appears to be flying because it is simply fitted into the backrest and inserted into the armrests. The designer's meticulous attention to detail found a true ally in B&B Italia Research & Development Centre which understands that the most essential products require a lot of work and special care. The result is noticeable in the constant play between the straight and curved lines, the relationship between the lightness of the wood, the strength of the raw-cut leather and the structural elements' vertical shape being softened by a curved section. Like a suspended bridge or a flying carpet, this gentle object conceives a new visual and perceptive balance which is elegant and comfortable.

La collezione B&B Italia 2019 introduce Pablo, una nuova seduta di Vincent Van Duysen. I suoi punti di forza sono la comodità e la decisione, che si uniscono a formare soluzioni estetiche e strutturali di forte impatto. Pablo presenta un doppio telo di cuoio che nella seduta custodisce una leggera imbottitura, appena percettibile alla vista ma capace di garantire comodità. La forma invitante è definita da una profondità accentuata e da un fronte leggermente inclinato: Pablo suggerisce proporzioni inedite e calibrate al millimetro, che rendono questa seduta un innovativo punto di incontro tra poltroncina e chaise longue. La struttura avvolge il corpo ed è sospesa, fluttuante, sembra volare poiché semplicemente calzata nello schienale e infilata nei braccioli. La meticolosa ricerca del dettaglio da parte del progettista ha trovato un valido alleato nella precisione del Centro Ricerche e Sviluppo B&B Italia, dove ben sanno che i prodotti più essenziali richiedono molto lavoro e una cura speciale. Il risultato si nota soprattutto nel contrappunto costante di linee rette e rotondità, nel rapporto tra la leggerezza del legno e la forza del cuoio tagliato a vivo, ma anche nel taglio degli elementi verticali della struttura ingentiliti da una sezione curva. Come un ponte sospeso o un tappeto volante, questo oggetto garbato concepisce un nuovo equilibrio visivo e percettivo, tanto elegante quanto confortevole.







page / pagina 32:  
**Pablo**  
armchair / poltrona  
**Milos**  
carpet / tappeto

pages / pagine 34-35:  
**Pablo**  
armchairs / poltrone





This bookcase system started as a stacking exercise of an assembly of rods of the same diameter. Its discipline lies in the structural rules used to build from one form to the next.

Questo sistema di libreria è nato come esercizio di assemblaggio di tondini dello stesso diametro. La sua disciplina deriva dalle regole strutturali utilizzate per passare da una forma a quella successiva.

After last year's great success, Jack returns with a range expanded by new structures, finishes and modules. In addition to the clean vertical floor to ceiling upright, Anastassiades has designed a new rod to be fixed to the wall, making Jack suitable for all those spaces that cannot provide the vertical anchorage for a bookcase.

Dopo il grande successo dello scorso anno, Jack ritorna e amplia la sua gamma con nuove strutture, nuove finiture e nuovi moduli. Oltre al pulitissimo montante verticale da pavimento a soffitto, Anastassiades ha disegnato una nuova asta da fissare a parete, rendendo Jack adatto a tutti quegli spazi che non possono prevedere l'ancoraggio verticale della libreria.







page / pagina 41:  
**Jack**  
modular bookcase / libreria modulare

opposite page / accanto:  
**Jack**  
modular bookcase / libreria modulare

**Pablo**  
armchair / poltrona

**Riso**  
carpet / tappeto

Together with the new structure (which can reach up to 328 cm in height), the growing family of elements have been combined to provide new, deeper shelves, storage elements such as drawers and flap doors. The precise technical solutions for the flap doors include an interesting cable-rolling system and a single elegant hinge that crosses the door along its length.

Insieme alla nuova struttura (che può arrivare fino a 328 cm di altezza), cresce la famiglia degli elementi da combinare, con nuovi ripiani più profondi, elementi contenitori come cassetti e ribalte. Le accurate soluzioni tecniche delle ribalte prevedono un interessante sistema a cavetto avvolgibile e un'unica elegante cerniera che attraversa l'anta per tutta la sua lunghezza.









pages / pagine 46-47:  
**Jack**  
modular bookcase / libreria modulare  
**Dock**  
modular sofa and bench /  
divano componibile e panca  
**Up1**  
armchair / poltrona  
**Spool**  
small table / tavolino  
**Milos**  
carpet / tappeto

opposite page / accanto:  
**Jack**  
modular bookcase / libreria modulare

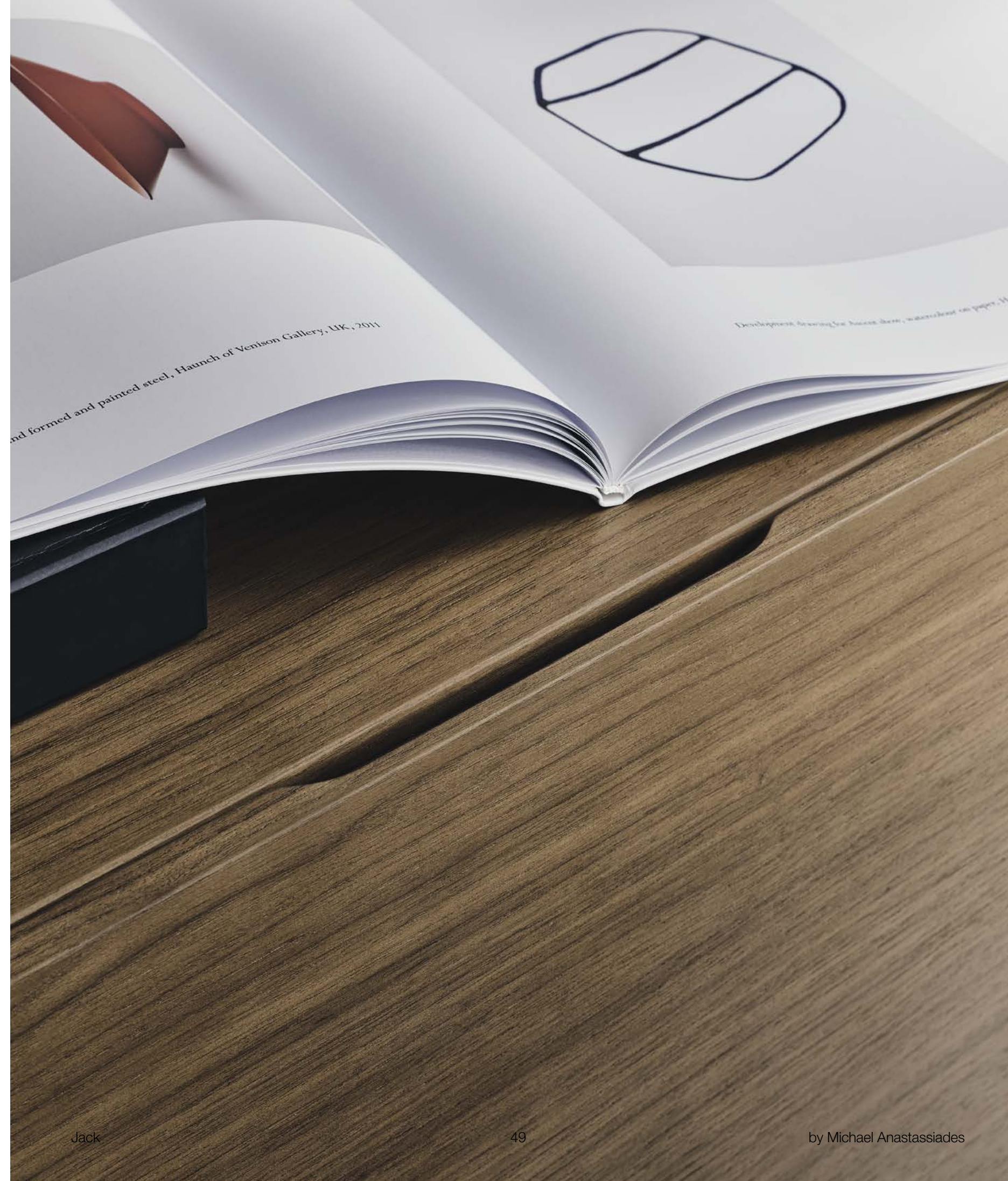





All the elements are available in black and white satin, to which canaletto walnut is added as an option for the tops and storage units and four oak finishes: light, grey, black and smoked. With these new additions, Jack is becoming a contemporary classic and a platform for countless stories and styles.

Tutti gli elementi prevedono la finitura satinata bianca e nera, a cui si aggiungono per i piani e i contenitori anche noce canaletto e quattro varianti di rovere, ovvero chiaro, grigio, nero e fumigato. Grazie a queste nuove integrazioni, Jack si avvia a diventare un classico contemporaneo, una piattaforma che sarà la base per innumerevoli storie e stili.

opposite page / accanto:  
**Jack**  
modular bookcase / libreria modulare  
**Milos**  
carpet / tappeto



This table creates  
a pure and monolithic  
presence, where  
apparent simplicity  
erases all that  
is superfluous.

Questo tavolo crea una presenza monolitica,  
pura e asciutta, dove la semplicità apparente  
cancella tutto ciò che è superfluo, rifiuta ogni manierismo.









page / pagina 53:  
**Parallel Structure**  
table / tavolo

pages / pagine 54-55:  
**Parallel Structure**  
table / tavolo  
**Jack**  
modular bookcase / libreria modulare  
**Jens**  
chairs / sedie  
**Riso**  
carpet / tappeto

pages / pagine 58, 61:  
**Parallel Structure**  
table / tavolo  
**Milos**  
carpet / tappeto



Two imposing aluminium bars joined by two side supports is the concept for the first table designed by Michael Anastassiades for B&B Italia. A basic structure with a minimal and essential vision, a concept that becomes an object. The search for extreme simplicity is often accompanied by the need to find cutting-edge technical solutions, and Parallel Structure is the perfect example. To respect the project's purity, great attention was paid to the detailing of the joins, the relationship between cleanliness of form and structural elements and the combination of different materials. The legs are in solid wood, while the side supports, architraves connecting the coloured aluminium bars, hide a metal core, necessary to provide solidity and greater visual lightness to the structure. The collection includes two sizes and tops in different materials: canaletto walnut and four variants of oak, light, grey, black and smoked, for a choice that favours minimal aesthetics or glass, which enhances the beauty of the engineering process through transparency. This table creates a pure and monolithic presence, where apparent simplicity erases all that is superfluous. Starting from its name, Parallel Structure is a product that naturally brings an architectural approach to the design world.

La presenza materica di due imponenti barre di alluminio semplicemente unite da due ponti laterali: questo il concetto che ha generato il primo tavolo di Michael Anastassiades per B&B Italia. Una struttura di base, una visione minima ed essenziale, un segno che diventa oggetto. Ma sappiamo che la ricerca della semplicità estrema si accompagna spesso alla necessità di trovare soluzioni tecniche d'avanguardia e Parallel Structure rappresenta l'esempio perfetto di questa tensione. Per rispettare la purezza del progetto, grande attenzione è stata dedicata allo studio delle giunzioni, al rapporto tra pulizia della forma ed elementi strutturali, al matrimonio tra materiali di natura molto diversa tra di loro. Le gambe sono in legno massello, mentre i ponti laterali, vere e proprie architravi che connettono le barre colorate in alluminio, nascondono un'anima in metallo, necessaria per fornire solidità e maggiore leggerezza visiva all'intera struttura. La collezione prevede due misure e piani in materiali diversi, legno di noce canaletto e quattro varianti di rovere: chiaro, grigio, nero e fumigato, per una scelta che privilegia un'estetica minima oppure vetro che attraverso la trasparenza esalta la bellezza del processo di ingegnerizzazione. Questo tavolo crea una presenza monolitica, pura e asciutta, dove la semplicità apparente cancella tutto ciò che è superfluo, rifiuta ogni manierismo. A partire dal nome, Parallel Structure si propone come un prodotto che porta con naturalezza nel mondo del design un approccio progettuale di matrice architettonica.









Bull expresses  
the feeling of a sturdy  
but extremely  
refined product at  
the same time.

Bull, nasce con l'intento di trasmettere  
la sensazione immediata di un oggetto di grande solidità,  
al contempo estremamente raffinato.



As suggested by the name, Bull was designed as a table that conveys the strength and robustness of the legs, and now the collection has been expanded to include a bench with the same features. A stylish design implemented with subtle structural tension between the elements: the wide legs with round section that, despite at a slight diagonal tilt, convey the sensation of being firmly “grounded”, which supports a delicately placed lightweight top, a contrasting feature to the legs. Simple cushions on the bench top complete the product, adding a touch of comfort.

Come suggerisce il suo nome, Bull nasce come un tavolo le cui gambe poggiano solidamente a terra ed ora si amplia con l’inserimento di una panca dalle medesime caratteristiche. Una formula stilistica che si riesce a raggiungere attraverso una sottile tensione strutturale tra gli elementi: le gambe dalla generosa sezione tonda che, sebbene leggermente inclinate, danno la sensazione di essere solidamente “piantate a terra” a reggere, per contrasto, un piano sottile che appare come fosse semplicemente appoggiato sulla struttura. Dei cuscini essenziali appoggiati sul piano della panca donano il corretto comfort e completano il progetto.



page / pagina 63:  
**Bull**  
bench and table / panca e tavolo  
**Riso**  
carpet / tappeto

opposite page / accanto:  
**Bull**  
bench / panca



Butterflies in flight.  
The design image was  
that of a seat that  
would “welcome”  
gracefully, with the  
graceful movement of  
a butterfly, which in  
Latin is called a papilio.

Il volo della farfalla. La visione progettuale è quella  
di una seduta che “accoglie” con grazia, la bellezza del movimento  
di una farfalla che in lingua latina si chiama appunto papilio.





The successful Papilio seating collection is expanded with the Papilio stool with the choice of two height options. Naoto Fukasawa, who favours the comfort of this product over the shape of the design, says, "I wanted the seat to look naturally comfortable, with the same shape relaxation would have if it were depicted with an image". The wings - armrests - placed on the sides of the seat enhance the comfortable feel. They support both sides and back of the stool.

Lo sgabello Papilio, disponibile in due altezze, completa e amplia una serie di sedute di grande successo, caratterizzate da una iconicità distintiva. Naoto Fukasawa, che all'interesse per le forme antepone quello per i comportamenti delle persone, afferma: "Volevo che la seduta apparisse confortevole in modo naturale, che avesse la stessa forma che potrebbe avere il relax se fosse rappresentato da un'immagine". Sono proprio "le ali" che si protendono ai lati della seduta che enfatizzano la sensazione di comfort, fungendo da supporto ai fianchi e alla schiena.



page / pagina 67:  
**Papilio**  
stools / sgabelli

opposite page / accanto:  
**Papilio**  
stools / sgabelli



This design recalls several historic models: from the nineteenth century “shaker” chairs to the 1950s-style chairs, all the way back to memories of the Ming dynasty.

Numerosi i riferimenti a modelli storici ripresi in questo progetto: dalle sedie “shaker” dell’ottocento alle sedie degli anni cinquanta del novecento, passando per le memorie della dinastia Ming.





Jens is a seating collection with a striking personality. It stands out for the explicit reference to the past, in terms of both style and materials. Combining classical and contemporary concepts, it is an exquisite piece, with expert craftsmanship shown in the curve of the wood. Moreover, the version with either cellulose rope or leather seat emphasizes the refined details and characteristics of the project. In 2019 the collection has expanded, with the addition of a stool with either a wooden or cellulose rope seat, depending on the colour combinations of the product.

Jens è una serie di sedute dalla forte identità, riconoscibile grazie ad un esplicito richiamo alla memoria sia nelle scelte stilistiche che nei materiali. Classica e contemporanea al tempo stesso rappresenta un pezzo di grande pregio che riscopre la manualità artigianale del legno tornito e curvato cui si aggiunge la versione con seduta in corda di cellulosa o in cuoio ad impreziosire e caratterizzare il progetto. Nel 2019 la collezione si amplia nelle funzionalità con l'introduzione di uno sgabello con seduta in legno o in corda di cellulosa secondo accostamenti cromatici definiti.





Rigorous lines, order,  
essential features.  
The minimal style  
emphasises the  
exceptional quality of  
materials and of  
production methods.



Rigore, ordine, essenzialità.  
Lo stile minimale mette in risalto la grande qualità dei materiali  
e delle lavorazioni per un pezzo di design intramontabile.





Rigorous lines, order, essential features. The minimal style emphasises the exceptional quality of materials and of production methods. Available in different sizes, the low table Pianura features a supporting frame in bright brushed aluminium, or painted in pewter or black chrome, upon which rests a thin top, which can be either made of matt white Carrara marble or matt black Marquinia marble, or the collection's various wood types. A practical thick leather-lined compartment can be added centrally on top for an elegant graphic detail.

Rigore, ordine, essenzialità. Lo stile minimale mette in risalto la grande qualità dei materiali e delle lavorazioni. Disponibile in varie dimensioni, il tavolino Pianura è composto da una elegante struttura in alluminio spazzolato lucido, verniciato peltro o verniciato cromato nero, che sostiene un sottile piano in marmo bianco Carrara, nero Marquinia opaco oppure in essenza, nelle varie finiture presenti in collezione. È possibile inoltre inserire al centro del piano un pratico vano divisorio rivestito in cuoio che dona un raffinato dettaglio grafico.





page / pagina 75:  
**Pianura**  
small table / tavolino

page / pagina 76:  
**Pianura**  
small table / tavolino  
**Diesis 40**  
sofa / divano  
**Jack**  
modular bookcase / libreria modulare  
**Up1**  
armchair / poltrona  
**Frank**  
ottoman / pouf  
**Timo**  
carpet / tappeto



## *Special editions*

Diesis 40,  
design Antonio Citterio  
and Paolo Nava

Up 50,  
design Gaetano Pesce



2019 marks the 40<sup>th</sup> anniversary of the first appearance of Diesis, an important landmark which has been celebrated with some design and structural updates.

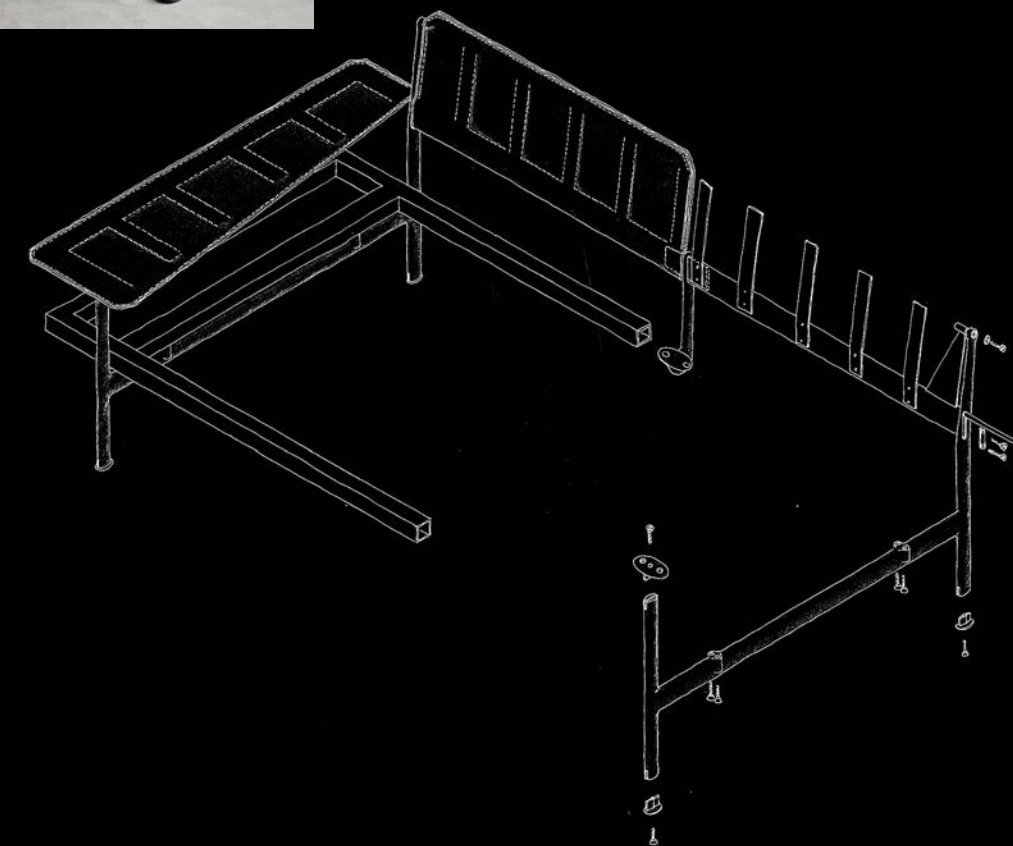
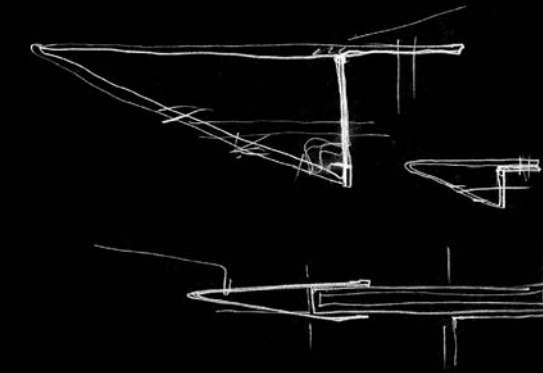

Il 2019 segna i 40 anni di Diesis dalla sua prima apparizione, un compleanno importante che viene celebrato con alcuni aggiornamenti di design e costruzione.

this page / in questa pagina:  
Antonio Citterio and Paolo Nava  
in their Monza office /  
Antonio Citterio e Paolo Nava  
nel loro studio di Monza  
Study drawing for Diesis design /  
Disegno di studio per il progetto  
di Diesis.



Diesis is not only a B&B Italia classic, but an absolute icon of contemporary design. 2019 marks the 40<sup>th</sup> anniversary of the first appearance of Diesis - an important landmark which has been celebrated with some design and structural updates. These updates return to the original concept while simultaneously advancing the design towards the future. The iconic backrest retains its essential and technical integrity based around the structural steel core, composed of metal springs which give strength and flexibility. The thick leather covered base and backrest are just like they were 40 years ago, but now have a distinctive Saffiano texture.

A tutti gli effetti Diesis rappresenta non soltanto un classico di B&B Italia, ma un'icona assoluta del design contemporaneo. Il 2019 segna i 40 anni dalla sua prima apparizione, un compleanno importante che viene celebrato con alcuni aggiornamenti di design e costruzione, all'insegna di un ritorno alle origini che allo stesso tempo rappresenta un'ulteriore avanzamento verso il suo futuro. Il caratteristico schienale conserva la sua natura essenziale e tecnica grazie all'anima in acciaio armonico, composta da balestre metalliche che danno robustezza e flessibilità. Come quarant'anni fa, la base e lo schienale tornano ad essere rivestiti in solido cuoio, che per la prima volta si presenta con un'inedita texture Saffiano.









page / pagina 85:  
**Diesis 40**  
chaise longue

pages / pagine 86-87:  
**Diesis 40**  
sofa / divano

opposite page / accanto:  
**Diesis 40**  
chaise longue







The supporting frame has a timeless elegance, which underlines Diesis' harmony with the vision of the great masters of Modernism. The cushions boast a new leather cover (available exclusively for Diesis 40) that accentuates the product's strength and vigour. This is softened by new and more comfortable upholstery. Reinforced seams and other techniques borrowed from saddlery draw attention to the authentic craftsmanship. Lovers of technical details will appreciate the die-cast lenticular elements of the polished brushed aluminium frame, and the seat structure which is further reduced by using two thick leather-covered coupled sheets. There are many further details to discover in Diesis 40. It is a great classic ready to face the next decades of its life.

La struttura portante conferma la sua eleganza senza tempo e sottolinea la sintonia di Diesis con le visioni dei grandi maestri del Movimento Moderno. I cuscini sono realizzati con un nuovo rivestimento in pelle (disponibile esclusivamente per Diesis 40) che accentua la forza e il vigore di questo prodotto, addolcito tuttavia da una nuova imbottitura ancora più soffice e accogliente. Le cuciture di rinforzo, le tecniche mutuata dalla selleria sono gli elementi che rinnovano l'attenzione per la manualità artigiana più autentica. Gli amanti dei dettagli tecnici apprezzeranno gli elementi lenticolari in pressofusione della struttura in alluminio spazzolata lucida, così come la struttura di seduta ulteriormente assottigliata grazie all'accoppiamento di due lamiera, anch'esse rivestite in cuoio. Sono moltissimi i nuovi dettagli da scoprire in Diesis 40, un grande classico pronto ad affrontare i suoi prossimi decenni di vita.









page / pagina 92:  
**Diesis 40**  
sofa / divano  
**Riso**  
carpet / tappeto

pages / pagine 94-95:  
**Diesis 40**  
sofas / divani  
**Pianura**  
small table / tavolino  
**Jack**  
modular bookcase / libreria modulare  
**Up1**  
armchair / poltrona  
**Frank**  
ottomans / pouf  
**Timo**  
carpet / tappeto  
**Riso**  
carpet / tappeto

opposite page / accanto:  
**Diesis 40**  
sofa / divano  
**Timo**  
carpet / tappeto



“At the time I was telling a personal story about my concept of women who have been prisoners of themselves.”

“In quel momento io raccontavo una storia personale su quello che è il mio concetto sulla donna: la donna è sempre stata, suo malgrado, prigioniera di sé.”

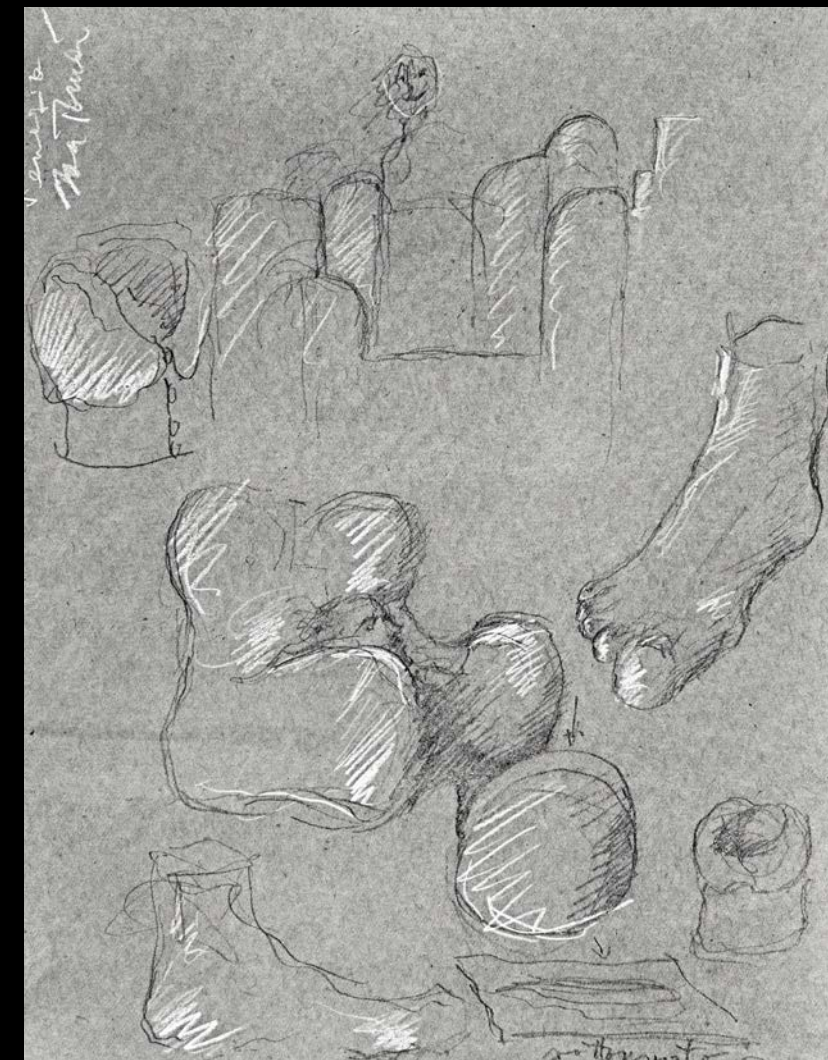

this page / in questa pagina:  
Gaetano Pesce  
(Photo By Young-Ah KIM for IDEAT)  
drawing for Serie Up / disegni per Serie UP  
Sequence of the stages  
of inflation of polyurethane UP5 /  
Sequenza delle fasi di  
"espansione" della poltrona UP5



To celebrate the fiftieth anniversary of Gaetano Pesce's Up5\_6, B&B Italia proposes the Special Edition striped beige/teal green, which refers to the original colour palette of 1969.

Per celebrare il cinquantenario della Up5\_6 di Gaetano Pesce, B&B Italia propone un'edizione speciale a righe beige/verde petrolio, che si rifà alla cartella colore originale del 1969.







pages / pagine 101, 102, 104-105:  
**Up 50**  
armchairs and ottomans /  
poltrone e pouf

opposite page / accanto:  
**Up 50**  
armchair / poltrona







## Product info

page / pagina 5:  
**Dock** - sofa / divano DA329D\_1 cover / rivestimento Koto 1119280 wooden base / base legno 0374C brushed light oak / rovere chiaro spazzolato support frame / struttura di sostegno 0782S satin chromed / cromato satinato

pages / pagine 6-7:  
**Dock** - modular sofa / divano componibile DA370D\_3+DA329AD\_2 cover / rivestimento Aiace 2576340 wooden base / base legno 0356N canaletto walnut / noce canaletto support frame / struttura di sostegno 0782S satin chromed / cromato satinato **Dock** - small table / tavolino TDA198\_1 top / piano 0356N canaletto walnut / noce canaletto support frame / struttura di sostegno 0782S satin chromed steel / acciaio cromato satinato **Jack** - modular bookcase / libreria modulare uprights and shelves / montanti e ripiani 3764E satin black painted / verniciato nero satinato **Up1** armchair / poltrona cover / rivestimento Soara 2163150 **Riso** - carpet / tappeto RST 0027C light / luce

pages / pagine 8-9:  
**Dock** - modular sofa / divano componibile DA370D\_3+DA329D\_2 cover / rivestimento Aiace 2576340 wooden base / base legno 0356N canaletto walnut / noce canaletto support frame / struttura di sostegno 0782S satin chromed / cromato satinato top / piano 0200T transparent extra light glass / vetro extra light trasparente **Dock** - small table / tavolino TDA198\_1 top / piano 0356N canaletto walnut / noce canaletto support frame / struttura di sostegno 0782S satin chromed steel / acciaio cromato satinato

pages / pagine 12-13:  
**Dock** - sofa / divano DA370\_1 cover / rivestimento Koto 1119280 wooden base / base legno 0374C brushed light oak / rovere chiaro spazzolato support frame / struttura di sostegno 0782S satin chromed / cromato satinato **Dock** - service elements / elementi di servizio TD23R support rod / asta di sostegno 0782S satin chromed / cromato satinato top / piano 0129F

smoky glass / vetro fumé **Riso** - carpet / tappeto RST 0027C light / luce

pages / pagine 14-15:  
**Dock** - modular sofa / divano componibile DAL230TS\_3+DAL150LD\_1 cover / rivestimento Salemi 2547220 wooden base / base legno 0374C brushed light oak / rovere chiaro spazzolato support frame / struttura di sostegno 0782S satin chromed / cromato satinato top / piano 0129F smoky glass / vetro fumé **Dock** - small table / tavolino TDA198\_1 top / piano 0374C brushed light oak / rovere chiaro spazzolato support frame / struttura di sostegno 0782S satin chromed / cromato satinato top / piano 0129F smoky glass / vetro fumé **Dock** - small table / tavolino TDA198\_1 top / piano 0374C brushed light oak / rovere chiaro spazzolato support frame / struttura di sostegno 0782S satin chromed / cromato satinato **Jack** - modular bookcase / libreria modulare uprights and shelves / montanti e ripiani 9118E satin chalk white / bianco gesso satinato **Pablo** - armchair / poltrona PB77 cover / rivestimento 1136420 mud green embossed thick leather / cuoio con grana verde fango frame / struttura 0374C brushed light oak / rovere chiaro spazzolato **Riso** - carpet / tappeto RST 0034D desert / deserto

page / pagina 17:  
**Dock** - modular sofa / divano componibile DAL230TS\_3+DAL150LD\_1 cover / rivestimento Salemi 2547220 base / base 0374C brushed light oak / rovere chiaro spazzolato support frame / struttura di sostegno 0782S satin chromed / cromato satinato **Dock** - service element / elemento di servizio TD36 support rod / asta di sostegno 0782S satin chromed / cromato satinato top / piano 0129F smoky glass / vetro fumé

pages / pagine 20-21, 23:  
**Dock** - modular sofa / divano componibile DBL370\_2+DBL370PD cover / rivestimento Salemi 2547205 wooden base / base legno 0374C brushed light oak / rovere chiaro spazzolato **Dock** - service elements / elementi di servizio TD36 support rod / asta di sostegno 0782S satin chromed / cromato satinato top / piano 0200T transparent extra light glass / vetro extra light trasparente **Dock** - armrest support / supporto bracciolo cover / rivestimento

Salemi 2547205 **Riso** - carpet / tappeto RST 0027C light / luce

pages / pagine 24-25:  
**Dock** - sofa / divano DA288 cover / rivestimento Koto 1119280 support frame / struttura di sostegno 0782S satin chromed / cromato satinato **Dock** - bench / panca DA180P\_1 cover / rivestimento Koto 1119280 support frame / struttura di sostegno 0782S satin chromed / cromato satinato **Pablo** - armchair / poltrona PB77N cover / rivestimento 1136150 black embossed thick leather / cuoio con grana nero frame / struttura 0356N canaletto walnut / noce canaletto **Pab** - storage system shelves / mensole 0990M matt Carrara "venatino statuarietto" white marble / marmo bianco Carrara "venatino statuarietto" opaco **Spool** - small table / tavolino TSP40 frame and top / struttura e piano 1346L glossy marsh brown / marrone palude lucido **Spool** - small table / tavolino TSP40 frame and top / struttura e piano 9110L glossy white / bianco lucido **Milos** - carpet / tappeto MLT 0134Q quartz / quarzo

page / pagina 27  
**Spool** - small table / tavolino TSP40 frame and top / struttura e piano 9110L glossy white / bianco lucido **Dock** - sofa / divano DA288 cover / rivestimento Koto 1119280 support frame / struttura di sostegno 0782S satin chromed / cromato satinato **Milos** - carpet / tappeto MLT 0134Q quartz / quarzo

page / pagina 28  
**Spool** - small tables / tavolini TSP40 frame and top / struttura e piano 9110L glossy white / bianco lucido 6020L glossy smoke blu / smoke blu lucido 1346L glossy marsh brown / marrone palude lucido 3751L glossy plum / prugna lucido 3764L glossy black / nero lucido

page / pagina 32:  
**Pablo** - armchair / poltrona PB77N cover / rivestimento 1121150

black thick leather / cuoio nero frame / struttura 0356N canaletto walnut / noce canaletto **Milos** - carpet / tappeto MLT 0134Q quartz / quarzo

pages / pagine 34-35:  
**Pablo** - armchair / poltrona PB77 cover / rivestimento 1136150 black embossed thick leather / cuoio con grana nero frame / struttura 0374C brushed light oak / rovere chiaro spazzolato **Pablo** - armchair / poltrona PB77 cover / rivestimento 1136750 bordeaux embossed thick leather / cuoio con grana bordeaux frame / struttura 0381N brushed black oak / rovere nero spazzolato **Pablo** - armchair / poltrona PB77 cover / rivestimento 1136100 natural embossed thick leather / cuoio con grana naturale frame / struttura 0374C brushed light oak / rovere chiaro spazzolato **Pablo** - armchair / poltrona PB77 cover / rivestimento 1136100 natural embossed thick leather / cuoio con grana naturale frame / struttura 0374C brushed light oak / rovere chiaro spazzolato **Pablo** - armchair / poltrona PB77 cover / rivestimento 1136420 mud green embossed thick leather / cuoio con grana verde fango frame / struttura 0378G grey oak / rovere grigio

page / pagina 41:  
**Jack** - modular bookcase / libreria modulare uprights and shelves / montanti e ripiani 9118E satin chalk white / bianco gesso satinato

page / pagina 42:  
**Jack** - modular bookcase / libreria modulare uprights and shelves / montanti e ripiani 9118E satin chalk white / bianco gesso satinato **Pablo** - armchair / poltrona PB77 cover / rivestimento 1136420 embossed thick leather mud green / cuoio con grana verde fango frame / struttura 0374C brushed light oak / rovere chiaro spazzolato **Riso** - carpet / tappeto RST 0027C light /luce

pages / pagine 45, 46-47:  
**Jack** - modular bookcase / libreria modulare uprights / montanti 3764E satin black / nero satinato shelves and storage units / ripiani e contenitori 0356N canaletto walnut / noce canaletto **Dock** - sofa / divano DA288 cover / rivestimento Koto 1119280 support frame / struttura di sostegno 0178C black chromed / cromato nero **Spool** - small table / tavolino TSP40 frame and top / struttura e piano

1346L glossy marsh brown / marrone palude lucido **Up1** - armchair / poltrona cover / rivestimento Soara 2163150 **Milos** - carpet / tappeto MLT 0134Q quartz / quarzo

page / pagina 50:  
**Jack** - modular bookcase / libreria modulare uprights and shelves / montanti e ripiani 3764E satin black / nero satinato **Milos** - carpet / tappeto MLT 0134Q quartz / quarzo

pages / pagine 54-55:  
**Parallel Structure** - table / tavolo PS28 frame / struttura 0356N canaletto walnut / noce canaletto top / piano 0356N canaletto walnut / noce canaletto support crosspieces / traverse di supporto 0076R red painted / verniciato rosso **Jack** - modular bookcase / libreria modulare uprights / montanti 3764E satin black / nero satinato shelves and storage units / ripiani e contenitori 0356N canaletto walnut / noce canaletto **Jens** - chairs / sedie SJ51B frame / struttura 0381N brushed black oak / rovere nero spazzolato cover / rivestimento 1136150 black embossed thick leather / cuoio con grana nero **Riso** - carpet / tappeto RST 0027C light /luce

pages / pagine 58, 61:  
**Parallel Structure** - table / tavolo PS28V frame / struttura 0374C brushed light oak / rovere chiaro spazzolato top / piano 0200T transparent extra light glass / vetro extra light trasparente support crosspieces /traverse di sostegno 0084B blue painted / verniciato blu **Milos** - carpet / tappeto MLT 0134Q quartz / quarzo

page / pagina 63:  
**Bull** - bench / panca TBU190 frame and top / struttura e piano 0381N brushed black oak / rovere nero spazzolato cushion cover / rivestimento cuscini Serra 2025153 **Bull** - table / tavolo TBU280M frame / struttura 0381N brushed black oak /rovere nero spazzolato top / piano 0955M matt Marquina black marble / marmo Marquina nero opaco **Riso** - carpet / tappeto RST

0027C light /luce

page / pagina 64:  
**Bull** - bench / panca TBU190 frame and top / struttura e piano 0381N brushed black oak / rovere nero spazzolato cushion cover / rivestimento cuscini Serra 2025153

page / pagina 67:  
**Papilio** - stools / sgabelli SP51A cover / rivestimento Serra 2025153 frame / struttura 0110M bright chromed / cromato lucido

page / pagina 68:  
**Papilio** - stools / sgabelli SP51B, SP51A cover / rivestimento Serra 2025153 frame / struttura 0110M bright chromed / cromato lucido

page / pagina 71:  
**Jens** - stools / sgabelli SJ41PAR\_A frame / struttura 0374C brushed light oak / rovere chiaro spazzolato seat / seduta 0601N natural cellulose rope / corda di cellulosa naturale

pages / pagine 72-73:  
**Jens** - stool / sgabello SJ41PAR\_A frame / struttura 0374C brushed light oak / rovere chiaro spazzolato seat / seduta 0601N natural cellulose rope / corda di cellulosa naturale **Jens** - stool / sgabello SJ41PAR\_B frame / struttura 0381N brushed black oak / rovere nero spazzolato seat / seduta 0650N black cellulose rope / corda di cellulosa nera **Jens** - stool / sgabello SJ41LR\_A frame and seat / struttura e seduta 0394T stained smoked oak / rovere tinto fumigato seat / seduta 0394T stained smoked oak / rovere tinto fumigato **Jens** - stool / sgabello SJ41LR\_B frame and seat / struttura e seduta 0381N brushed black oak / rovere nero spazzolato

pages / pagine 58, 61:  
**Parallel Structure** - table / tavolo PS28V frame / struttura 0374C brushed light oak / rovere chiaro spazzolato top / piano 0200T transparent extra light glass / vetro extra light trasparente support crosspieces /traverse di sostegno 0084B blue painted / verniciato blu **Milos** - carpet / tappeto MLT 0134Q quartz / quarzo

page / pagina 75:  
**Pianura** - small table / tavolino PN180\_2V frame / struttura 0189A bright brushed / spazzolato lucido top / piano 0955M matt Marquina black marble / marmo Marquina opaco tray / vassoio 0189A natural Saffiano thick leather / cuoio Saffiano naturale

page / pagina 76:  
**Pianura** - small table / tavolino PN180\_2V frame / struttura 0189A

bright brushed / spazzolato lucido top / piano 0890M matt Carrara white marble / marmo Carrara bianco opaco tray / vassoio 1121300 natural thick leather / cuoio naturale **Up1** - armchair / poltrona cover / rivestimento Soara 2163150 **Jack** - modular bookcase / libreria modulare uprights and shelves / montanti e ripiani 9118E satin chalk / bianco gesso satinato **Frank** - ottoman / pouf F58P cover / rivestimento Serra 2025259 **Timo** - carpet / tappeto TMT4 0022G grey / grigio

page / pagina 85:  
**Diesis 40** - chaise longue 40D135LS frame / struttura 0189A bright brushed / spazzolato lucido frame cover / rivestimento struttura 01144150 black Saffiano thick leather / cuoio Saffiano nero cushions cover / rivestimento cuscini 1229150 black Kos leather / pelle Kos nero profiles / profili 1130150 black eco-leather / ecopelle nero

pages / pagine 86-87:  
**Diesis 40** - sofa / divano 40D277 frame / struttura 0189A bright brushed / spazzolato lucido frame cover / rivestimento struttura 01144150 black Saffiano thick leather / cuoio Saffiano nero cushions cover / rivestimento cuscini 1229150 black Kos leather / pelle Kos nero profiles / profili 1130150 black eco-leather / ecopelle nero

page / pagina 88:  
**Diesis 40** - chaise longue 40D135LS - 40D135LD frame / struttura 0189A bright brushed / spazzolato lucido frame cover / rivestimento struttura 01144150 black Saffiano thick leather / cuoio Saffiano nero cushions cover / rivestimento cuscini 1229150 black Kos leather / pelle Kos nero profiles / profili 1130150 black eco-leather / ecopelle nero

page / pagina 92:  
**Diesis 40** - sofa / divano 40D277 frame / struttura 0189A bright brushed / spazzolato lucido frame cover / rivestimento struttura 1144300 natural Saffiano thick leather / cuoio Saffiano naturale cushions cover / rivestimento cuscini 1229300 naturale Kos leather / pelle Kos naturale profiles / profili 1130106 natural eco-leather / ecopelle naturale

pages / pagine 101, 102:  
**Up 50** - armchair and ottoman / poltrona e pouf 50UP5\_6B armchair cover / rivestimento poltrona Soara 2109140 ottoman cover / rivestimento pouf Soara 2163420

page / pagina 92:  
**Diesis 40** - sofa / divano 40D277 frame / struttura 0189A bright brushed / spazzolato lucido frame cover / rivestimento struttura 1144300 natural Saffiano thick leather / cuoio Saffiano naturale cushions cover / rivestimento cuscini 1229300 naturale Kos leather / pelle Kos naturale profiles / profili 1130106 natural eco-leather / ecopelle naturale

**Riso** - carpet / tappeto RST 0027C light /luce

pages / pagine 94-95:  
**Diesis 40** - sofas / divani 40D277 frame / struttura 0189A bright brushed / spazzolato lucido frame cover / rivestimento struttura 1144300 natural Saffiano thick leather / cuoio Saffiano naturale cushions cover / rivestimento cuscini 1229300 naturale Kos leather / pelle Kos naturale profiles / profili 1130106 natural eco-leather / ecopelle naturale **Pianura** - small table / tavolino PN180\_2V frame / struttura 0189A bright brushed / spazzolato lucido top / piano 0890M matt Carrara white marble / marmo Carrara bianco opaco tray / vassoio 1121300 natural thick leather / cuoio naturale **Up1** - armchair / poltrona cover / rivestimento Soara 2163150 **Jack** - modular bookcase / libreria modulare uprights and shelves / montanti e ripiani 9118E satin chalk white / bianco gesso satinato **Frank** - ottomans / pouf F58P cover / rivestimento Serra 2025259 **Timo** - carpet / tappeto TMT4 0022G grey / grigio

page / pagina 96:  
**Diesis 40** - sofa / divano 40D277 frame / struttura 0189A bright brushed / spazzolato lucido frame cover / rivestimento struttura 1144300 natural Saffiano thick leather / cuoio Saffiano naturale cushions cover / rivestimento cuscini 1229300 naturale Kos leather / pelle Kos naturale profiles / profili 1130106 natural eco-leather / ecopelle naturale **Timo** - carpet / tappeto RST 0027C light /luce

page / pagina 96:  
**Diesis 40** - sofa / divano 40D277 frame / struttura 0189A bright brushed / spazzolato lucido frame cover / rivestimento struttura 1144300 natural Saffiano thick leather / cuoio Saffiano naturale cushions cover / rivestimento cuscini 1229300 naturale Kos leather / pelle Kos naturale profiles / profili 1130106 natural eco-leather / ecopelle naturale **Timo** - carpet / tappeto RST 0027C light /luce

pages / pagine 101, 102:  
**Up 50** - armchair and ottoman / poltrona e pouf 50UP5\_6B armchair cover / rivestimento poltrona Soara 2109140 ottoman cover / rivestimento pouf Soara 2163420

pages / pagine 104- 05:  
**Up 50** - armchair and pouf / poltrona e pouf 50UP5\_6 armchair cover / rivestimento poltrona Soara 2109140 ottomans cover / rivestimento pouf Soara 2109140



Technical data  
Schede tecniche



# Dock by Piero Lissoni

SOFAS WITH HIGH BASE / DIVANI CON BASE ALTA

**DAL198**  
**DA198**

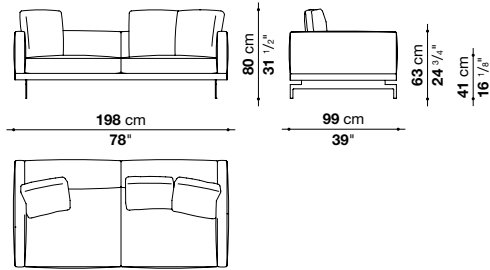

\* **DAL239D\_2**  
\* **DA239D\_2**

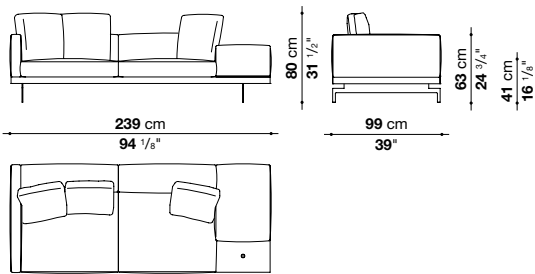

**DAL280\_2**  
**DA280\_2**

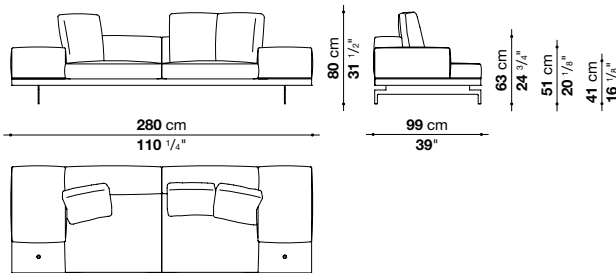

**DAL288**  
**DA288**

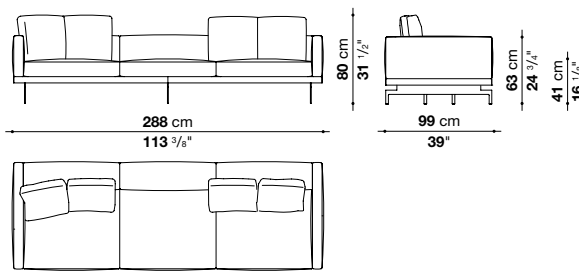

\* **DAL239D\_1**  
\* **DA239D\_1**

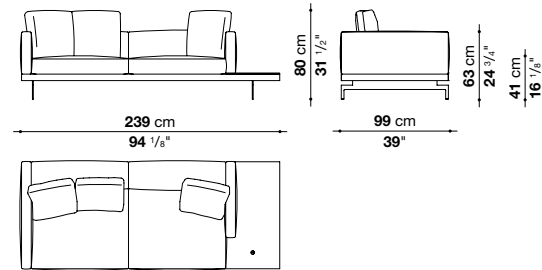

**DAL280\_1**  
**DA280\_1**

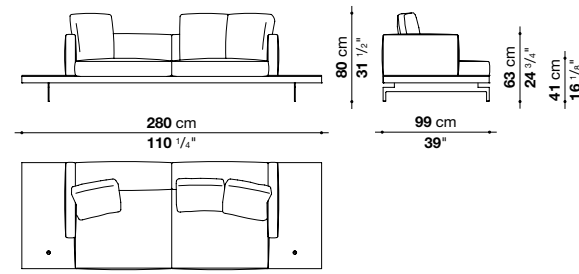

\* **DAL280D\_3**  
\* **DA280D\_3**

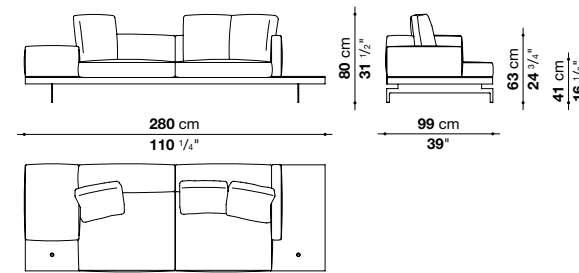

\* **DAL329D\_1**  
\* **DA329D\_1**

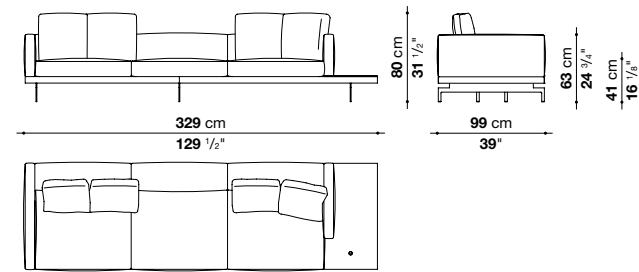

SOFAS WITH HIGH BASE / DIVANI CON BASE ALTA

\* **DAL329D\_2**  
\* **DA329D\_2**

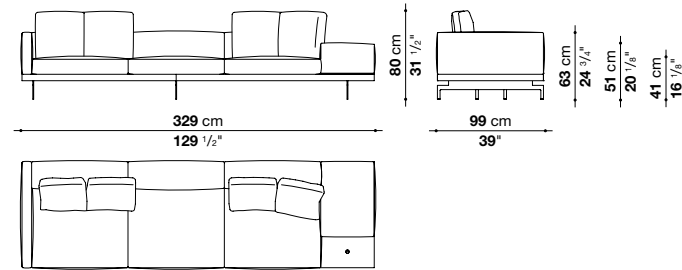

**DAL370\_2**  
**DA370\_2**

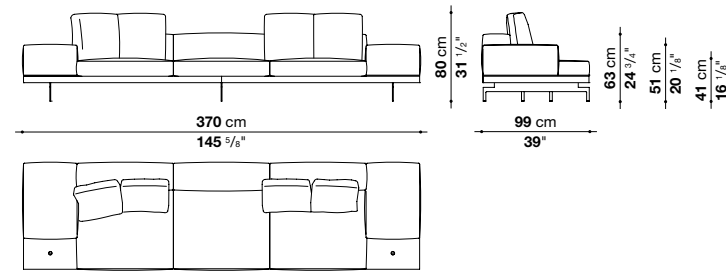

**DAL370\_1**  
**DA370\_1**

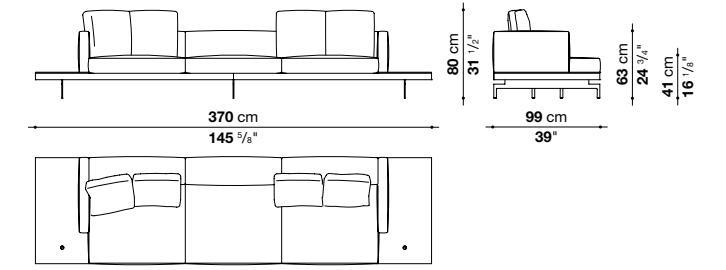

\* **DAL370D\_3**  
\* **DA370D\_3**

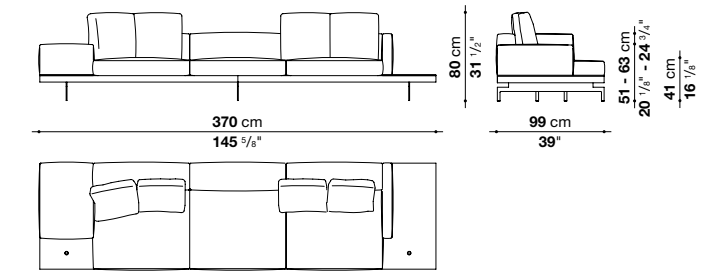

TERMINAL ELEMENTS WITH HIGH BASE / ELEMENTI TERMINALI CON BASE ALTA

\* **DAL189TD**  
\* **DA189TD**

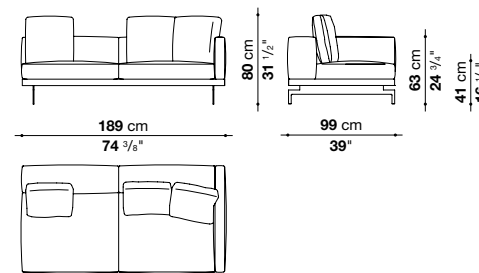

\* **DAL230TD\_1**  
\* **DA230TD\_1**

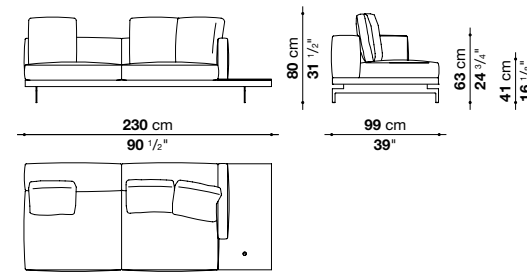

\* **DAL189TD\_1**  
\* **DA189TD\_1**

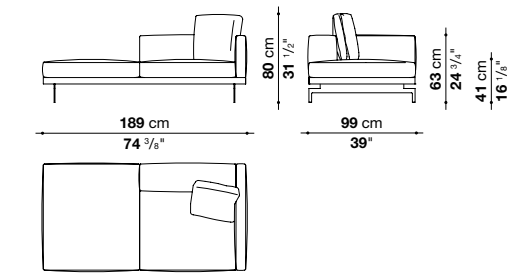

\* **DAL230TD\_2**  
\* **DA230TD\_2**

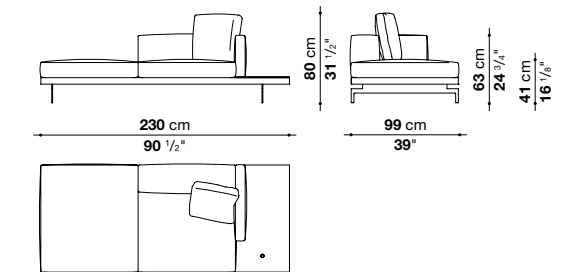

\* Elements available in right and left version. / Elementi disponibili nella versione destra e sinistra.

\* Elements available in right and left version. / Elementi disponibili nella versione destra e sinistra.



# Dock by Piero Lissoni

TERMINAL ELEMENTS WITH HIGH BASE / ELEMENTI TERMINALI CON BASE ALTA

- \* DAL230TD\_3
- \* DA230TD\_3

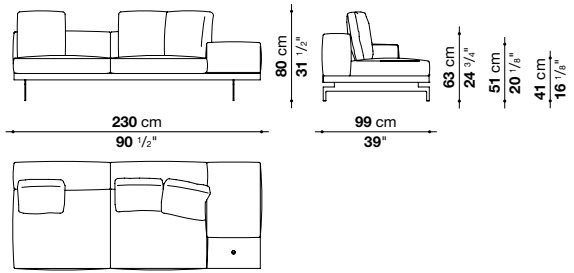

- \* DAL230TD\_4
- \* DA230TD\_4

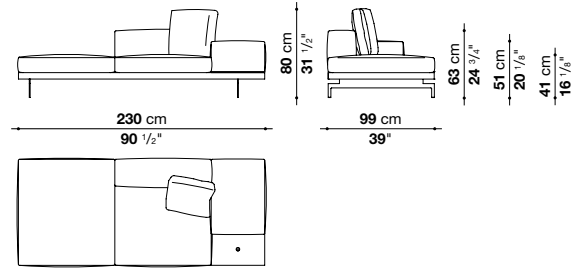

- \* DAL279TD
- \* DA279TD

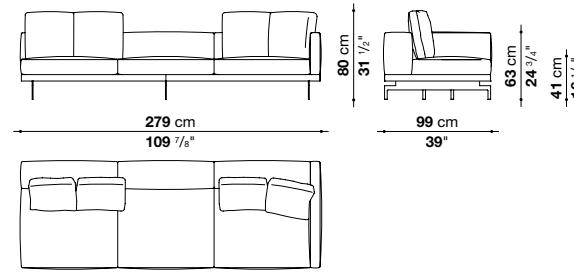

- \* DAL279TD\_1
- \* DA279TD\_1

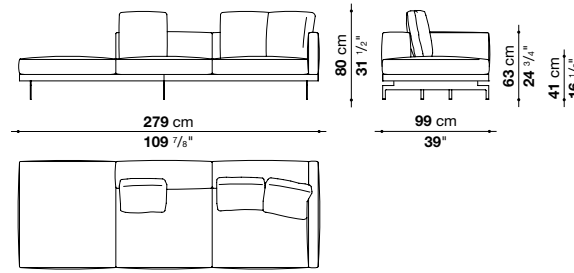

- \* DAL320TD\_1
- \* DA320TD\_1

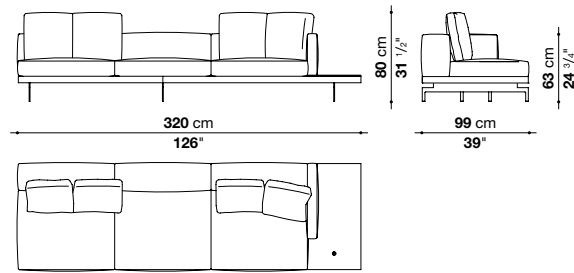

- \* DAL320TD\_2
- \* DA320TD\_2

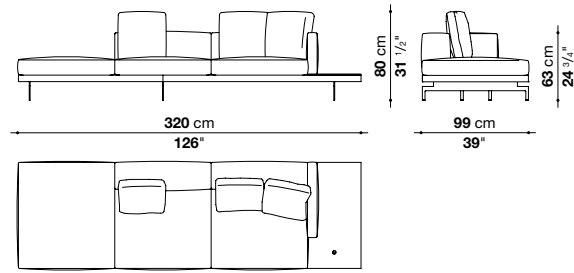

- \* DAL320TD\_3
- \* DA320TD\_3

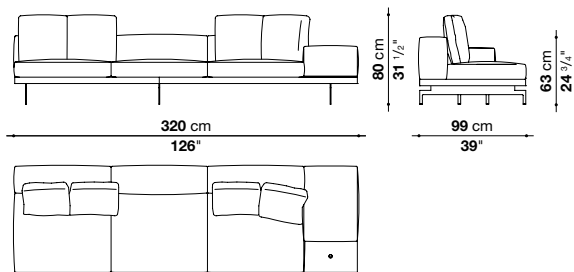

- \* DAL320TD\_4
- \* DA320TD\_4

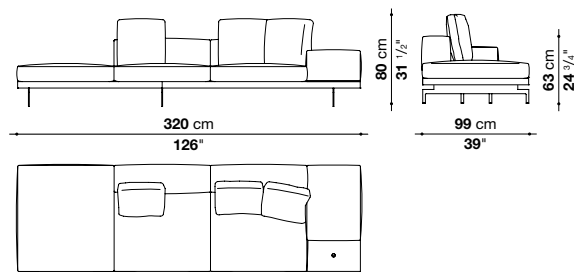

CORNER ELEMENTS WITH HIGH BASE / ELEMENTI ANGOLARI CON BASE ALTA

- \* DAL189AD
- \* DA189AD

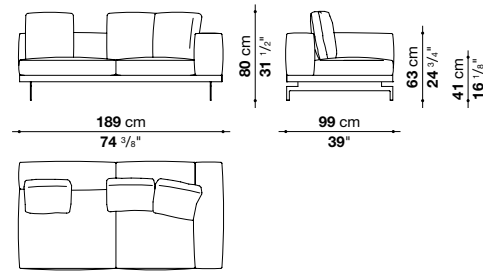

- \* DAL189AD\_1
- \* DA189AD\_1

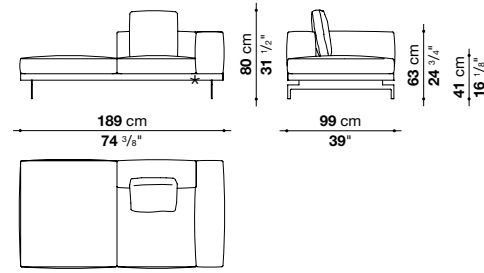

- \* DAL279AD
- \* DA279AD

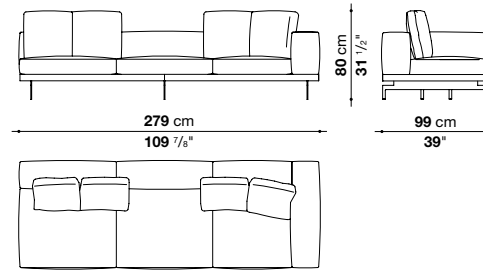

- \* DAL279AD\_1
- \* DA279AD\_1

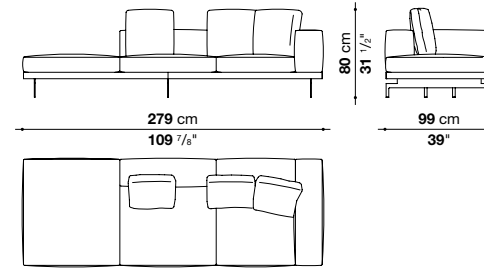

- \* DAL279AD\_2
- \* DA279AD\_2

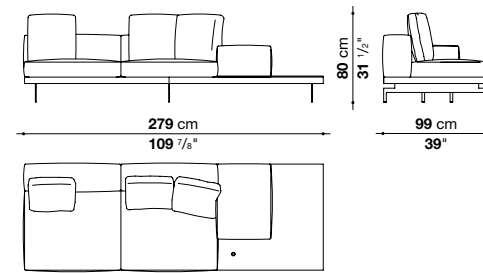

- \* DAL279AD\_3
- \* DA279AD\_3

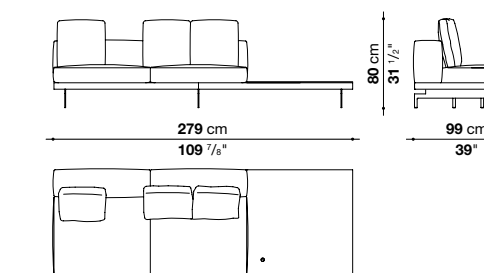

- \* DAL288AD
- \* DA288AD

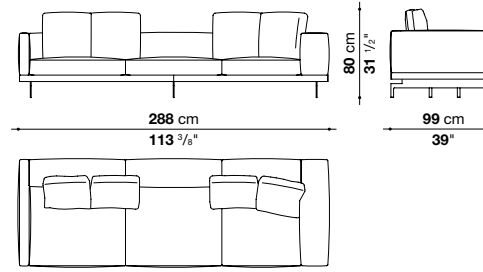

- \* DAL288AD\_1
- \* DA288AD\_1

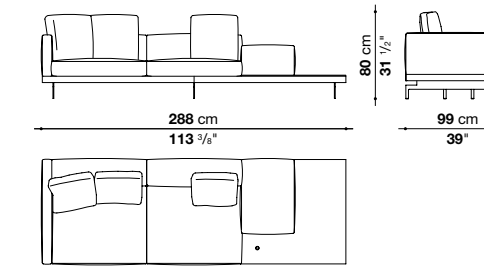

\* Elements available in right and left version. / Elementi disponibili nella versione destra e sinistra.

\* Elements available in right and left version. / Elementi disponibili nella versione destra e sinistra.

# Dock by Piero Lissoni

CORNER ELEMENTS WITH HIGH BASE / ELEMENTI ANGOLARI CON BASE ALTA

\* DAL288AD\_2  
\* DA288AD\_2

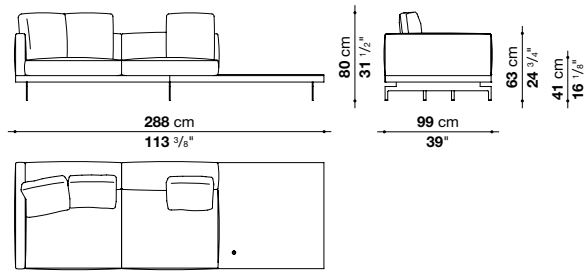

\* DAL329AD\_1  
\* DA329AD\_1

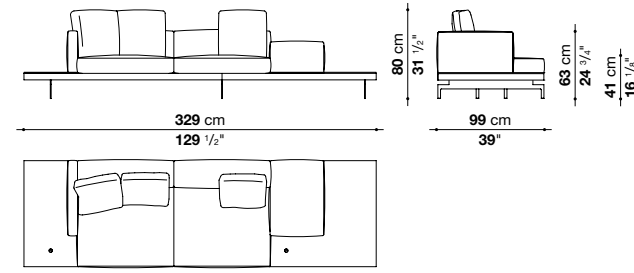

\* DAL329AD\_2  
\* DA329AD\_2

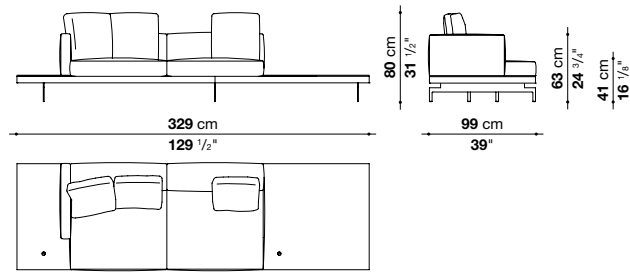

\* DAL329AD\_3  
\* DA329AD\_3

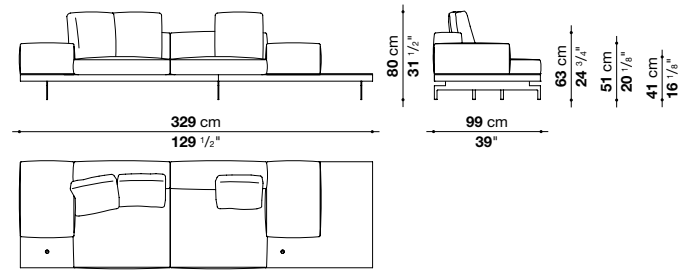

\* DAL329AD\_4  
\* DA329AD\_4

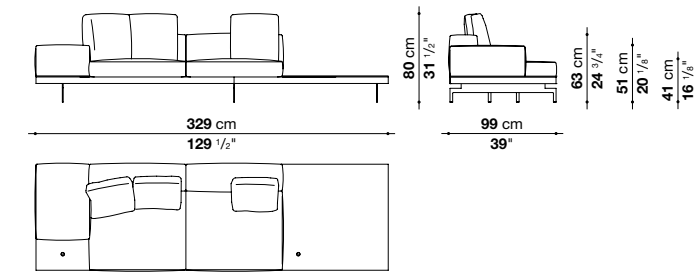

CHAISE LONGUE WITH HIGH BASE / CHAISE LONGUE CON BASE ALTA

\* DAL99LD  
\* DA99LD

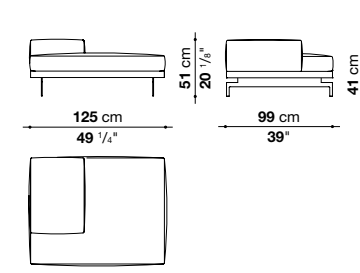

\* DAL150LD\_1  
\* DA150LD\_1

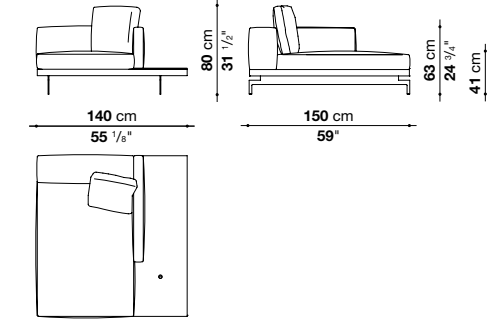

\* DAL150LD\_2  
\* DA150LD\_2

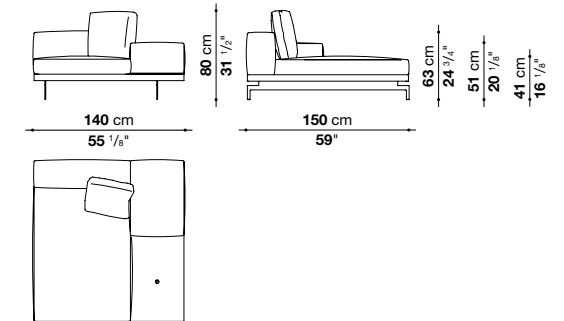

BENCHES WITH HIGH BASE / PANCHE CON BASE ALTA

DAL180P\_1  
DA180P\_1

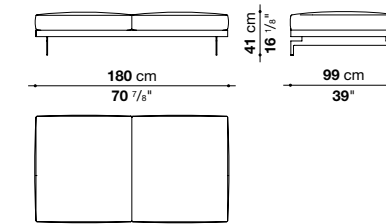

DAL180P\_2  
DA180P\_2

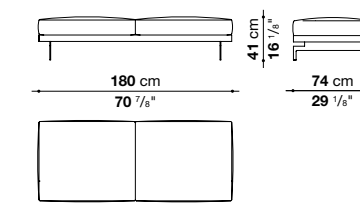

DAL270P\_1  
DA270P\_1

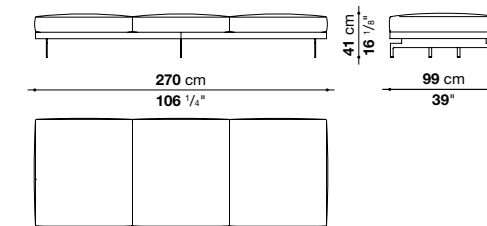

DAL270P\_2  
DA270P\_2

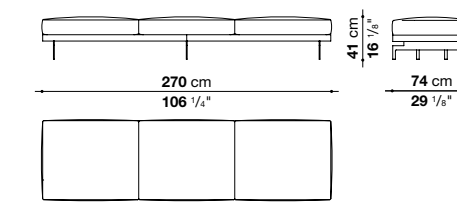

\* DAL230PD  
\* DA230PD

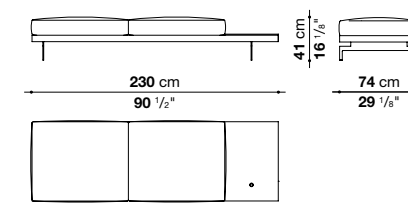

DAL280P  
DA280P

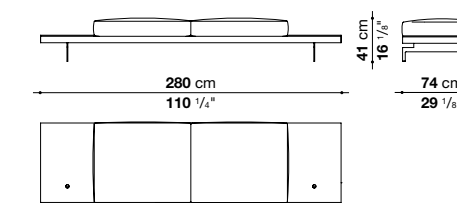

\* Elements available in right and left version. / Elementi disponibili nella versione destra e sinistra.

\* Elements available in right and left version. / Elementi disponibili nella versione destra e sinistra.



# Dock by Piero Lissoni

BENCHES WITH HIGH BASE / PANCHE CON BASE ALTA

\* DAL320PD\_1  
\* DA320PD\_1

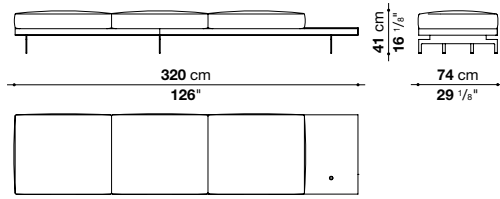

\* DAL320PD\_2  
\* DA320PD\_2

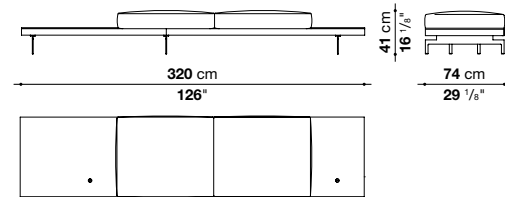

DAL370P  
DA370P

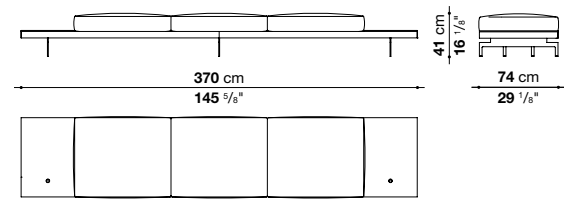

\* DAL370PD  
\* DA370PD

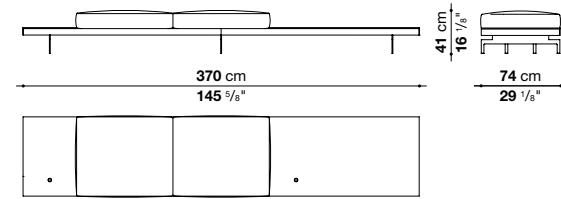

SOFAS WITH LOW BASE / DIVANI CON BASE BASSA

DBL198  
DB198

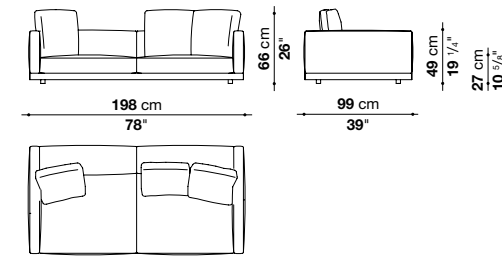

\* DBL239D\_1  
\* DB239D\_1

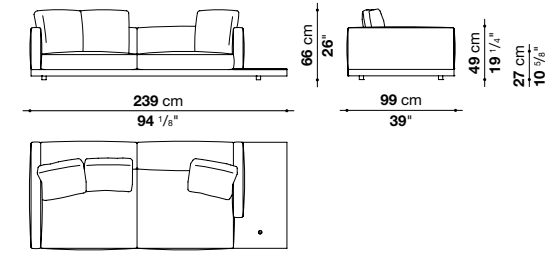

\* DBL239D\_2  
\* DB329D\_2

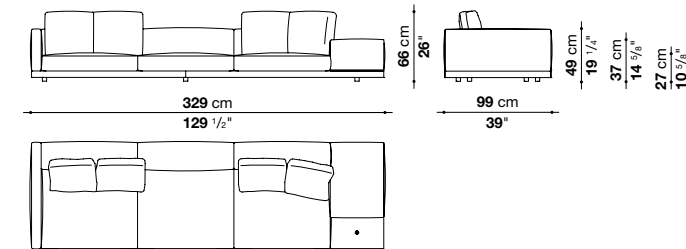

DBL280\_1  
DB280\_1

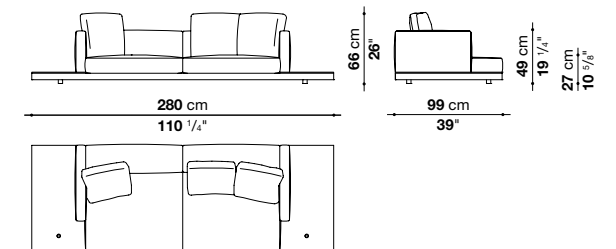

DBL280\_2  
DB280\_2

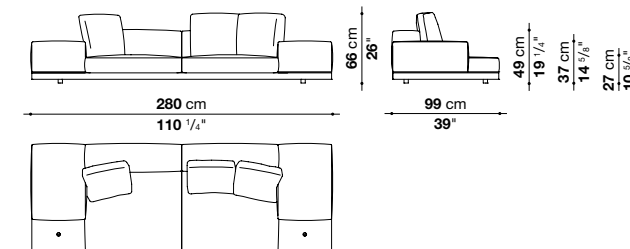

\* DBL280D\_3  
\* DB280D\_3

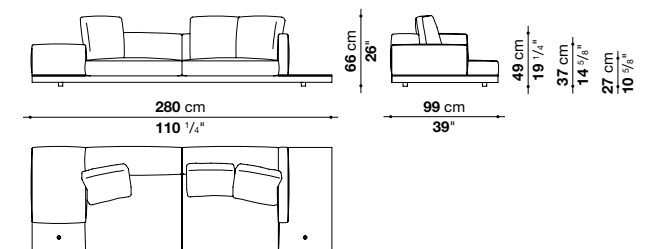

DBL288  
DB288

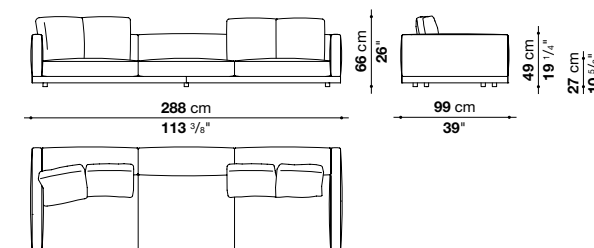

\* DBL239D\_1  
\* DB329D\_1

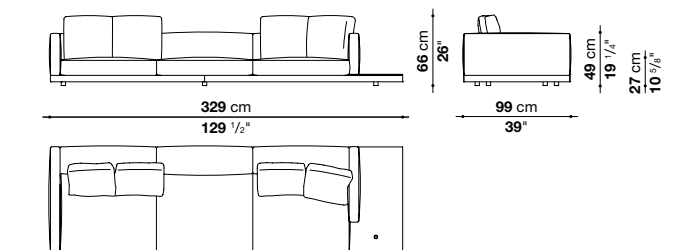

\* Elements available in right and left version. / Elementi disponibili nella versione destra e sinistra.

\* Elements available in right and left version. / Elementi disponibili nella versione destra e sinistra.

# Dock by Piero Lissoni

SOFAS WITH LOW BASE / DIVANI CON BASE BASSA

\* DBL329D\_2  
\* DB329D\_2

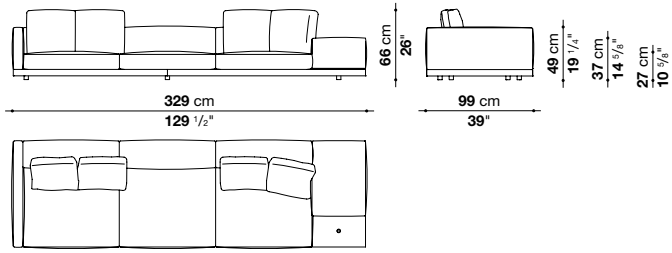

DBL370\_2  
DB370\_2

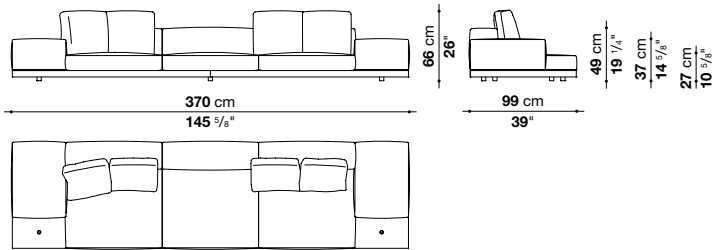

DBL370\_1  
DB370\_1

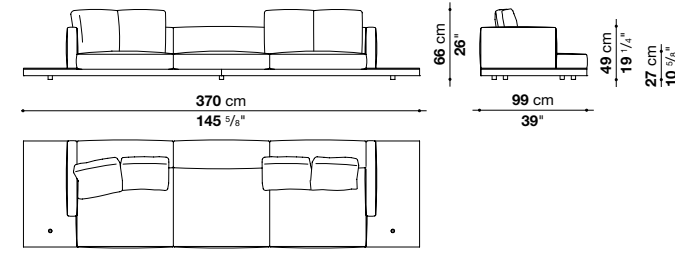

\* DBL370D\_3  
\* DB370D\_3

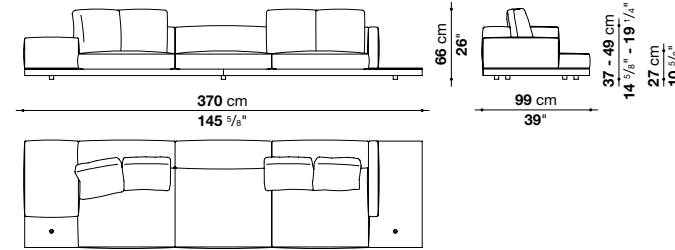

TERMINAL ELEMENTS WITH LOW BASE / ELEMENTI TERMINALI CON BASE BASSA

\* DBL189TD  
\* DB189TD

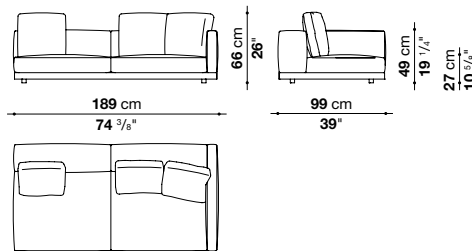

\* DBL230TD\_1  
\* DB230TD\_1

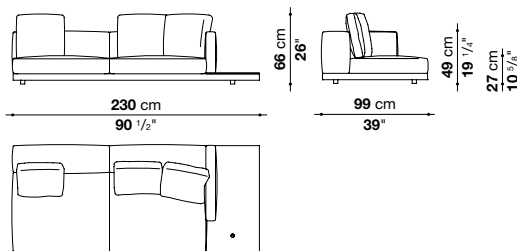

\* DBL189TD\_1  
\* DB189TD\_1

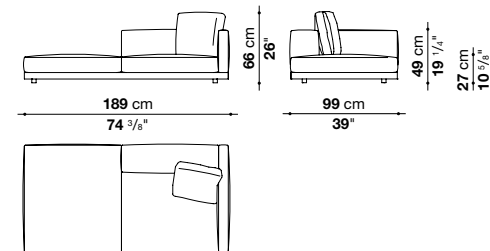

\* DBL230TD\_2  
\* DB230TD\_2

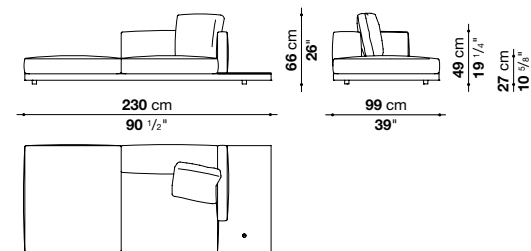

TERMINAL ELEMENTS WITH LOW BASE / ELEMENTI TERMINALI CON BASE BASSA

\* DBL230TD\_3  
\* DB230TD\_3

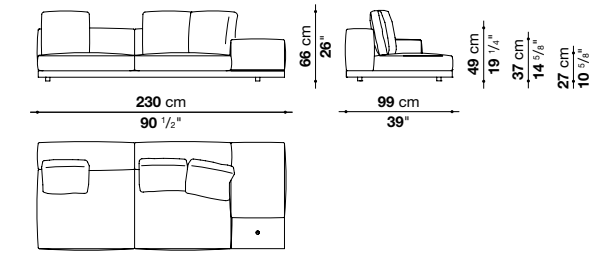

\* DBL279TD  
\* DB279TD

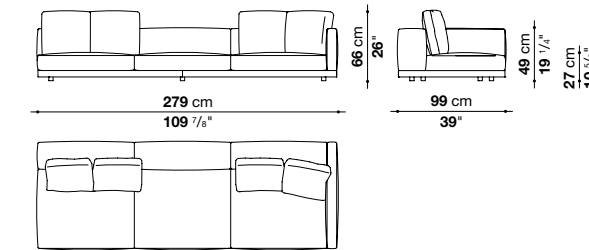

\* DBL230TD\_4  
\* DB230TD\_4

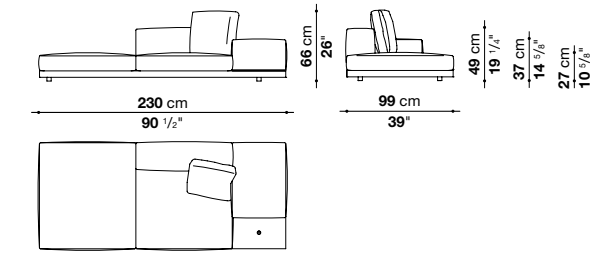

\* DBL279TD\_1  
\* DB279TD\_1

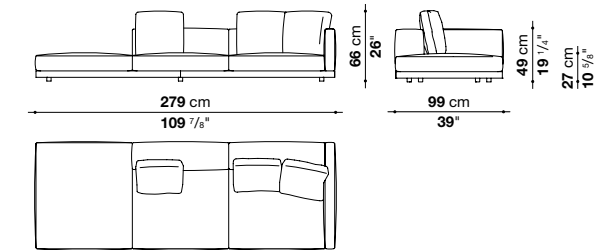

\* DBL320TD\_1  
\* DB320TD\_1

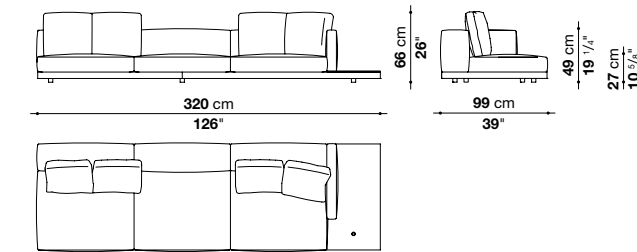

\* DBL320TD\_3  
\* DB320TD\_3

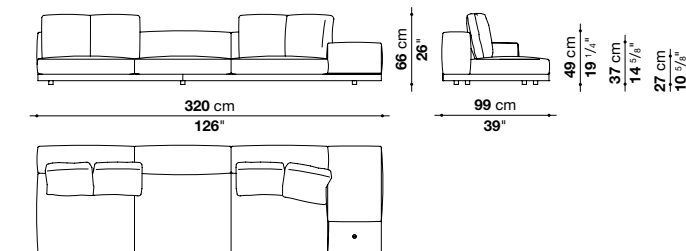

\* DBL320TD\_2  
\* DB320TD\_2

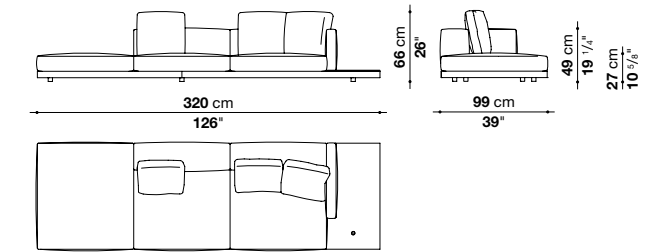

\* DBL320TD\_4  
\* DB320TD\_4

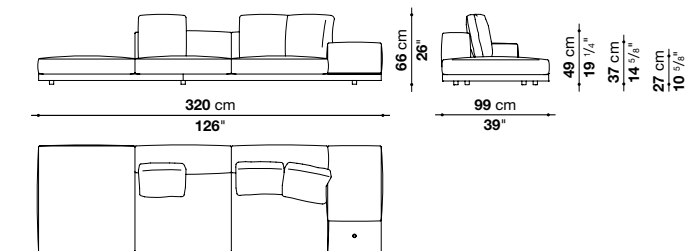

\* Elements available in right and left version. / Elementi disponibili nella versione destra e sinistra.

\* Elements available in right and left version. / Elementi disponibili nella versione destra e sinistra.



# Dock by Piero Lissoni

CORNER ELEMENTS WITH LOW BASE / ELEMENTI ANGOLARI CON BASE BASSA

\* DBL189AD  
\* DB189AD

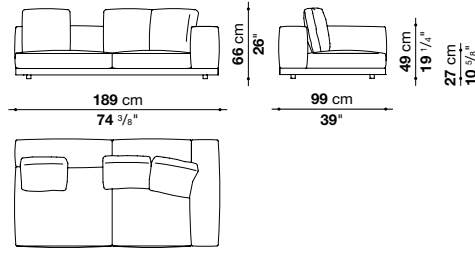

\* DBL189AD\_1  
\* DB189AD\_1

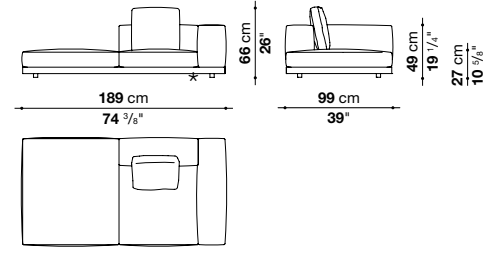

\* DBL279AD  
\* DB279AD

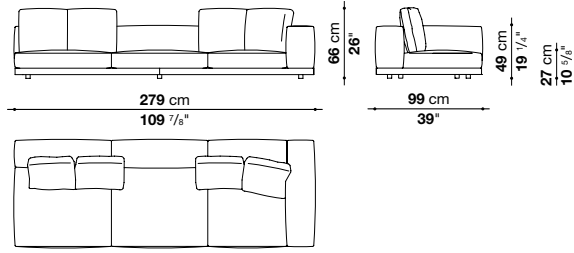

\* DBL279AD\_1  
\* DB279AD\_1

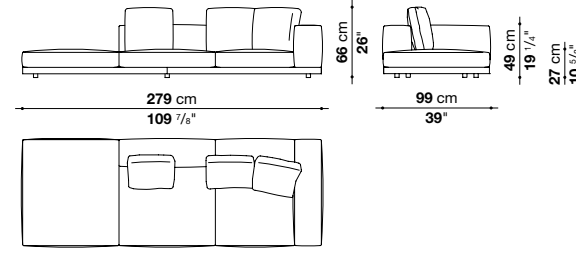

\* DBL279AD\_2  
\* DB279AD\_2

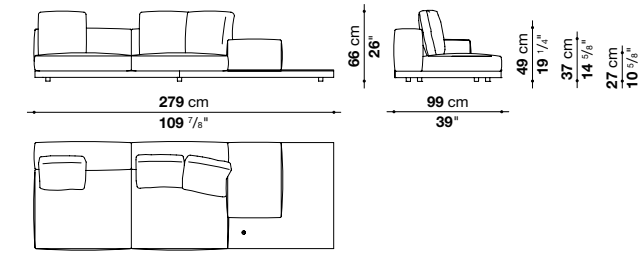

\* DBL279AD\_3  
\* DB279AD\_3

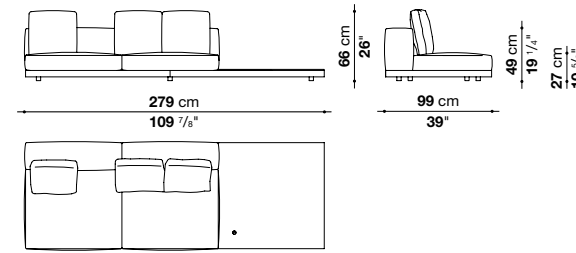

\* DBL288AD  
\* DB288AD

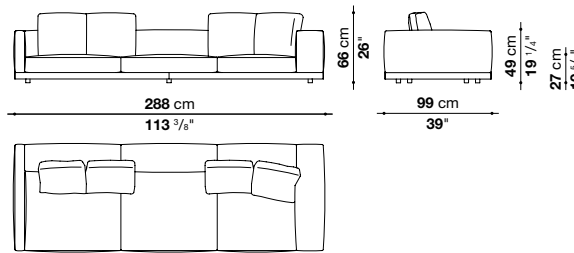

\* DBL288AD\_1  
\* DB288AD\_1

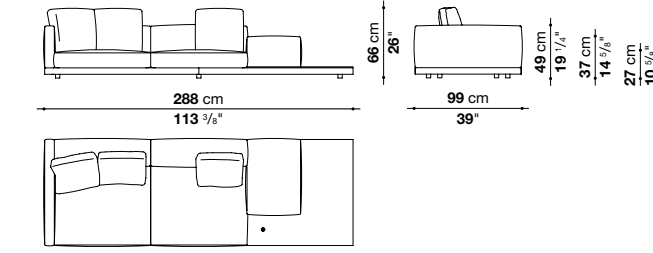

CORNER ELEMENTS WITH LOW BASE / ELEMENTI ANGOLARI CON BASE BASSA

\* DBL288AD\_2  
\* DB288AD\_2

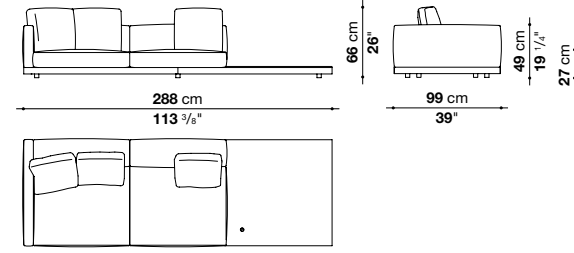

\* DBL329AD\_1  
\* DB329AD\_1

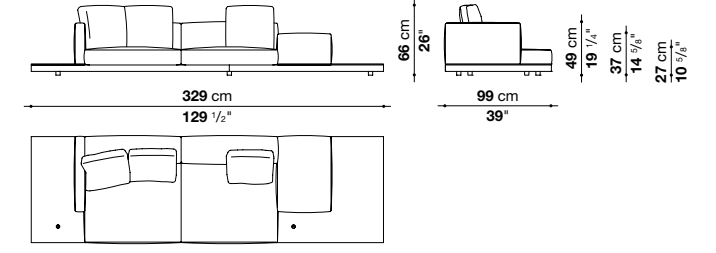

\* DBL329AD\_2  
\* DB329AD\_2

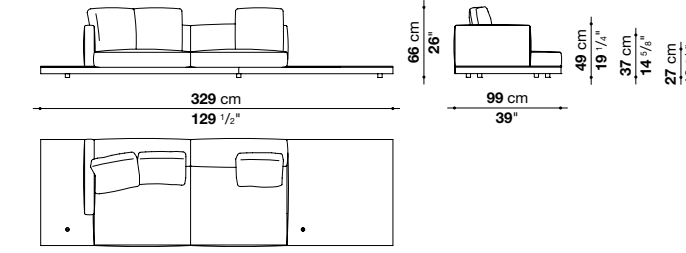

\* DBL329AD\_3  
\* DB329AD\_3

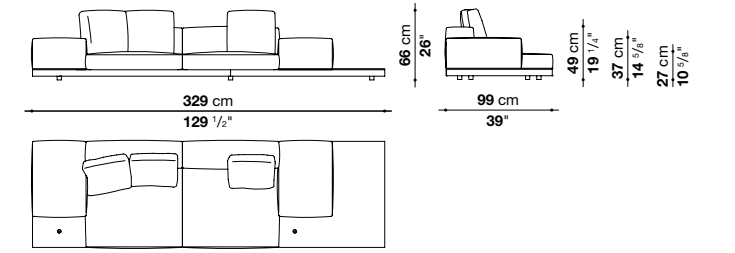

\* DBL329AD\_4  
\* DB329AD\_4

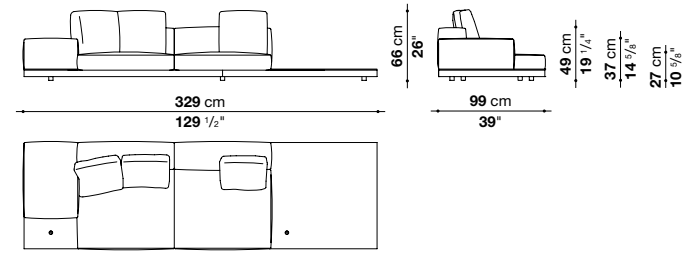

\* Elements available in right and left version. / Elementi disponibili nella versione destra e sinistra.

\* Elements available in right and left version. / Elementi disponibili nella versione destra e sinistra.

# Dock by Piero Lissoni

CHAISE LONGUE WITH LOW BASE / CHAISE LONGUE CON BASE BASSA

\* DBL99LD  
\* DB99LD

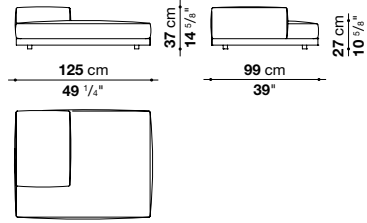

\* DBL150LD\_1  
\* DB150LD\_1

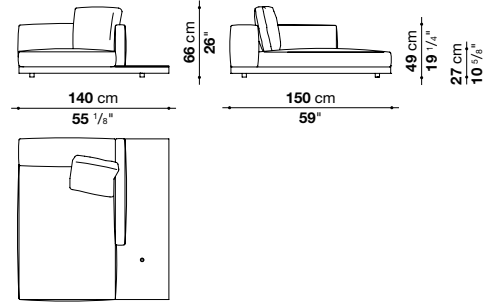

\* DBL150LD\_2  
\* DB150LD\_2

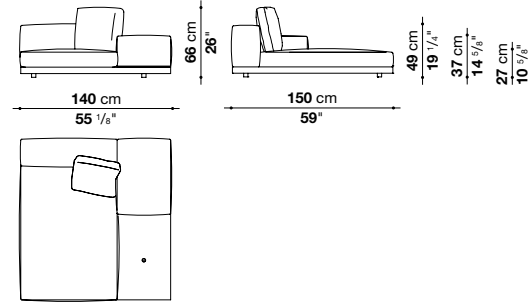

BENCHES WITH LOW BASE / PANCHE CON BASE BASSA

\* DBL320PD\_1  
\* DB320PD\_1

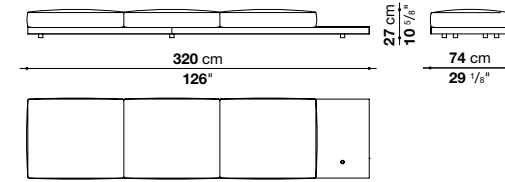

\* DBL320PD\_2  
\* DB320PD\_2

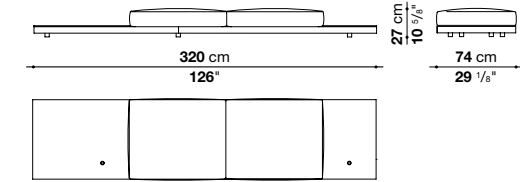

BENCHES WITH LOW BASE / PANCHE CON BASE BASSA

DBL180P\_1  
DB180P\_1

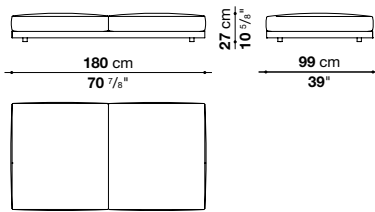

DBL180P\_2  
DB180P\_2

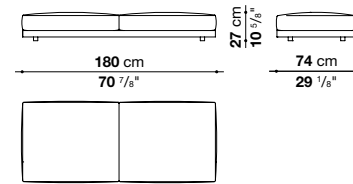

DBL270P\_1  
DB270P\_1

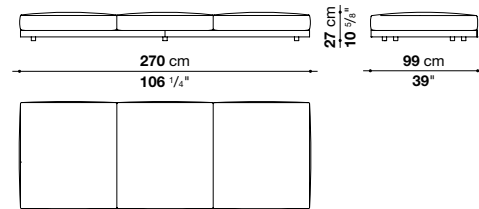

DBL270P\_2  
DB270P\_2

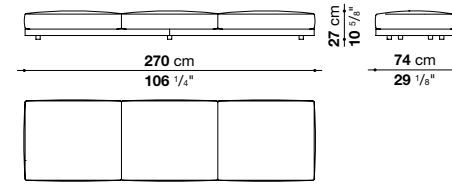

\* DBL230PD  
\* DB230PD

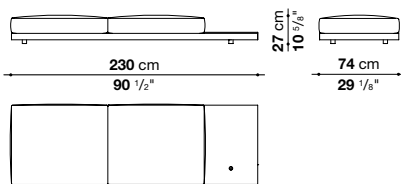

DBL280P  
DB280P

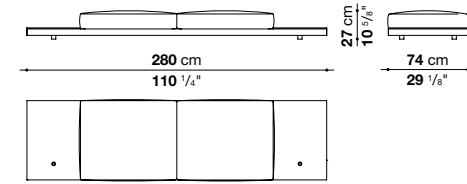

DBL370P  
DB370P

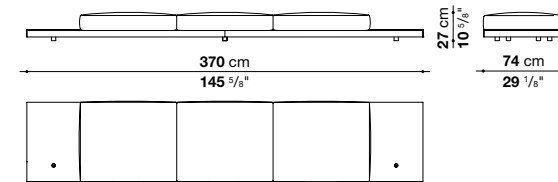

\* DBL370PD  
\* DB370PD

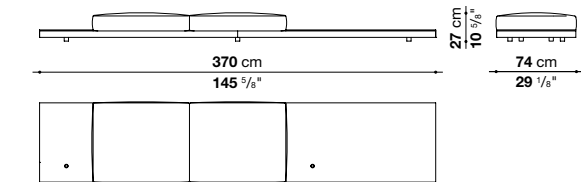

SERVICE ELEMENTS / ELEMENTI DI SERVIZIO

DA31B

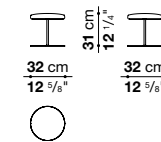

TD23R

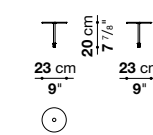

TD36

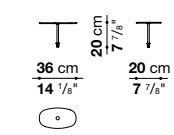

TDA31

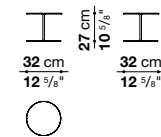

TD23RL

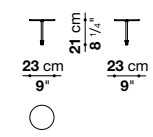

TD36L

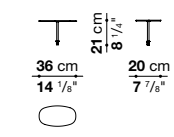

\* Elements available in right and left version. / Elementi disponibili nella versione destra e sinistra.

\* Elements available in right and left version. / Elementi disponibili nella versione destra e sinistra.



## Dock by Piero Lissoni

<b>Seat internal frame (covered base)</b>	tubular steel and steel profiles, multi-layered wood panel, polyester fibre cover
<b>Seat internal frame (wooden base)</b>	tubular steel and steel profiles, veneered multi-layered wood panel, solid wood
<b>Back and armrest internal frame</b>	tubular steel and steel profiles
<b>Seat cushion upholstery</b>	shaped polyurethane of different density, sterilized down, polyester fibre cover
<b>Back cushion upholstery</b>	sterilized down, polyester fibre cover
<b>Top</b>	veneered MDF wood fibre panel
<b>Cap</b>	steel
<b>Support frame (high version)</b>	steel profiles
<b>Feet (low version)</b>	thermoplastic material
<b>Armrest support (DA31B)</b>	aluminium and steel
<b>Armrest top (DA31B)</b>	solid wood, shaped polyurethane of different density, polyester fibre cover
<b>Service element support</b>	steel
<b>Service element top (TD23R-TD36)</b>	glass
<b>Service element top (TDA31L-D23RL-TD36L)</b>	solid wood
<b>Ferrules</b>	plastic material
<b>Cover</b>	fabric (cannetè profile) or leather

<b>Telaio interno sedile (base rivestita)</b>	tubolari e profilati d'acciaio, pannello in multistrato di legno, fodera in fibra di poliestere
<b>Telaio interno sedile (base legno)</b>	tubolari e profilati d'acciaio, pannello in multistrato di legno impiallacciato, legno massello
<b>Telaio interno schienale e bracciolo</b>	tubolari e profilati d'acciaio
<b>Imbottitura cuscino sedile</b>	poliuretano sagomato a densità differenziata, piuma sterilizzata, fodera in fibra di poliestere
<b>Imbottitura cuscino schienale</b>	piuma sterilizzata, fodera in fibra di poliestere
<b>Piano</b>	pannello in fibra di legno MDF impiallacciato
<b>Capsula</b>	acciaio
<b>Struttura di sostegno (versione alta)</b>	profilati d'acciaio
<b>Piedini (versione bassa)</b>	materiale termoplastico
<b>Supporto bracciolo (DA31B)</b>	alluminio e acciaio
<b>Piano bracciolo (DA31B)</b>	legno massello, poliuretano sagomato a densità differenziata, fodera in fibra di poliestere
<b>Supporto elemento di servizio</b>	acciaio
<b>Piano elemento di servizio (TD23R-TD36)</b>	vetro
<b>Piano elemento di servizio (TDA31L-D23RL-TD36L)</b>	legno massello
<b>Puntali</b>	materiale plastico
<b>Rivestimento</b>	tessuto (profilo cannetè) o pelle

### Base Base



0374C  
brushed light oak  
rovere chiaro spazzolato



0378G  
grey oak  
rovere grigio



0381N  
brushed black oak  
rovere nero spazzolato



0370F  
smoked oak  
rovere fumigato



0356N  
canaletto walnut  
noce canaletto

### Support frame Struttura di sostegno

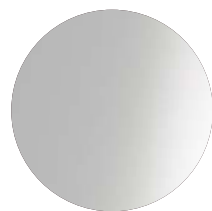

0782S  
satin chromed  
cromato satinato



0178C  
black chromed  
cromato satinato

### Top (TDA31L-TD23RL-TD36L) Piano

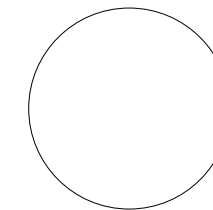

All the colours range  
glossy painted  
Tutta la gamma dei colori  
verniciato lucido

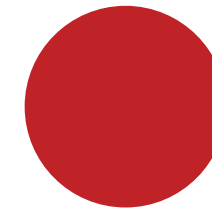

2002L  
candy red glossy painted  
verniciato candy red lucido

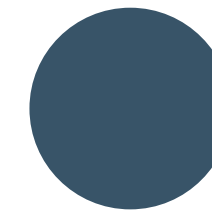

6020L  
smoke blue glossy painted  
verniciato smoke blue lucido



0374C  
brushed light oak  
rovere chiaro spazzolato



0378G  
grey oak  
rovere grigio



0381N  
brushed black oak  
rovere nero spazzolato



0370F  
smoked oak  
rovere fumigato



0356N  
canaletto walnut  
noce canaletto

### Glass top (TD23R-TD36) Piano in vetro

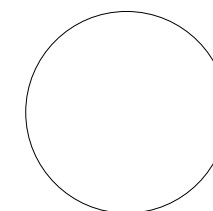

0200T  
transparent extra light glass  
vetro extra light trasparente

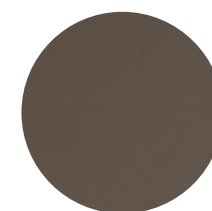

0129F  
smoky glass  
vetro fumé

## Dock by Piero Lissoni

SMALL TABLES / TAVOLINI

### TDA198\_1

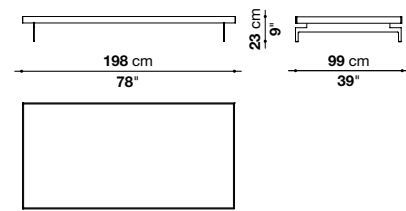

<b>Support frame</b>	steel profiles
<b>Top</b>	veneered multi-layered wood panel, solid wood
<b>Ferrules</b>	plastic material

### TDA198\_2

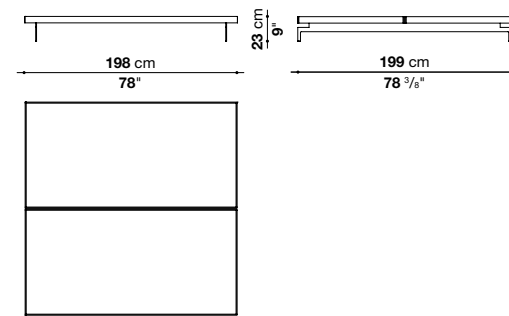

<b>Struttura di sostegno</b>	profilati d'acciaio
<b>Piano</b>	pannello in multistrato di legno impiallacciato, legno massello
<b>Puntali</b>	materiale plastico

### Top Piano



0374C  
brushed light oak  
rovere chiaro spazzolato



0378G  
grey oak  
rovere grigio



0381N  
brushed black oak  
rovere nero spazzolato



0370F  
smoked oak  
rovere fumigato



0356N  
canaletto walnut  
noce canaletto

### Support frame Struttura di sostegno

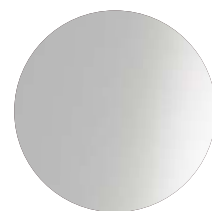

0782S  
satin chromed  
cromato satinato



0178C  
black chromed  
cromato satinato

## Spool by Piero Lissoni

### TSP40

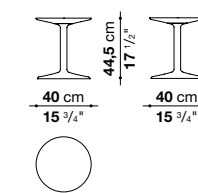

<b>Top and frame</b>	hard polyurethane
<b>Internal pin</b>	steel
<b>Ferrules</b>	felt

<b>Piano e struttura</b>	poliuretano rigido
<b>Perno interno</b>	acciaio
<b>Puntali</b>	feltro

### Top and frame Piano e struttura

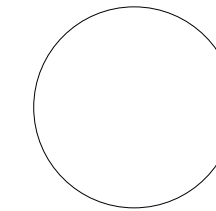

All the colours range  
glossy painted  
Tutta la gamma  
dei colori verniciato lucido

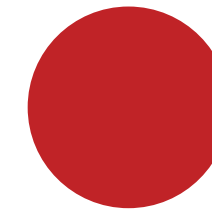

2002L  
candy red glossy painted  
verniciato candy red lucido

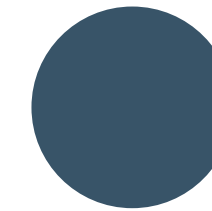

6020L  
smoke blue glossy painted  
verniciato smoke blue lucido.



## Dock by Piero Lissoni

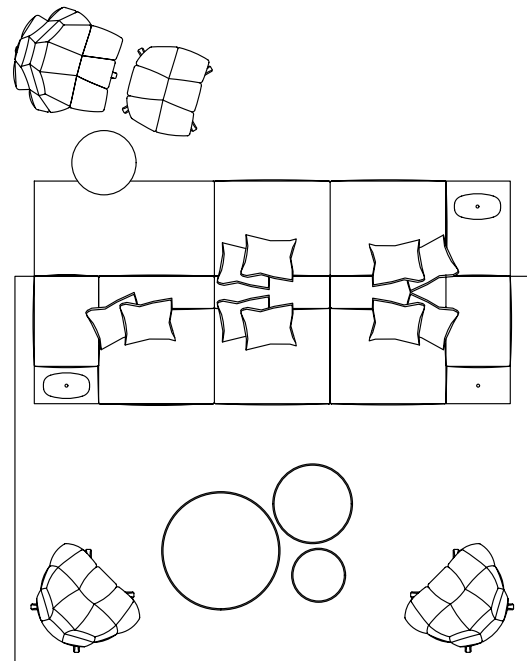

**Dock** - modular sofa / divano componibile  
DB370\_2+DB370PD  
cover / rivestimento  
Salemi 2547205  
base / base  
0374C  
brushed light oak / rovere chiaro spazzolato

**Dock** - service element / elemento di servizio  
TD39  
top / piano  
0129F  
smoky glass / vetro fumè

**Spool** - small table / tavolino  
TSP40  
top and frame / piano e struttura  
1343L  
glossy thyme green / verde timo lucido

**Husk** - armchair and ottoman / poltrona e pouf  
H3G+HP4  
base-frame / struttura di sostegno  
0156N  
black painted hard polyurethane / poliuretano rigido verniciato nero  
shell / scocca  
0015N  
black / nera  
cover / rivestimento  
Scozia 2489151

**Fat-Fat** - small tables / tavolini  
TFF92+TFF42  
frame / struttura  
0110M  
bright chromed / cromato lucido  
top / piano  
0151L  
chalk white painted / verniciato bianco gesso

**Husk** - armchair / poltrona  
H4G  
base-frame / struttura di sostegno  
0156N  
black painted hard polyurethane / poliuretano rigido verniciato nero  
shell / scocca  
0015N  
black / nero  
cover / rivestimento  
Serra 2025259

**Timo** - carpet / tappeto  
TMT4  
0081N  
black / nero

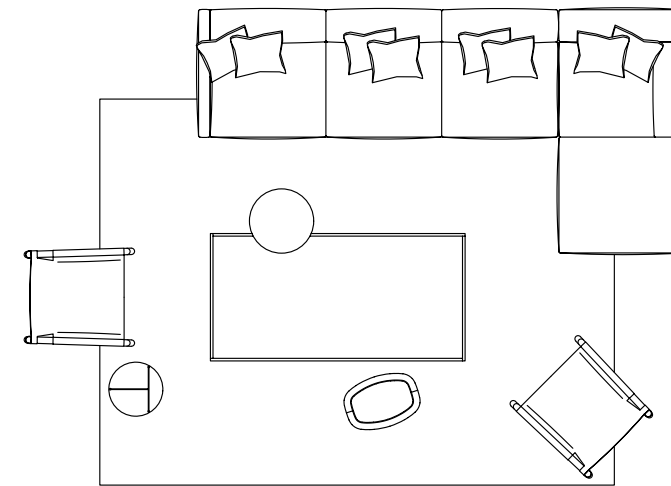

**Dock** - modular sofa / divano componibile  
DA279TS+DA189AS\_1  
cover / rivestimento  
Salemi 2547205  
support frame / struttura di sostegno  
0782S  
satin chromed steel / acciaio cromato satinato

**Dock** - small table / tavolino  
TDA198\_1  
0378G  
grey oak / rovere grigio  
support frame / struttura di sostegno  
0782S  
satin chromed steel / acciaio cromato satinato

**Spool** - small table / tavolino  
TSP40  
top and frame / piano e struttura  
6020L  
glossy smoke blue / smoke blue lucido

**Pablo** - armchair / poltrona  
PB77  
frame / struttura  
0374C  
brushed light oak / rovere chiaro spazzolato  
cover / rivestimento  
1136420  
embossed thick leather mud green / cuoio con grana verde fango

**Frank** - ottoman / pouf  
F58P  
cover / rivestimento  
Sirio 2053444

**Formiche** - small tables / tavolini  
FR42  
top / piano  
0200T  
transparent extra light glass / vetro extra light trasparente  
support frame / struttura di sostegno  
0259V  
painted pewter / verniciato petro

**Timo** - carpet / tappeto  
TMT4  
0022G  
grey / grigio

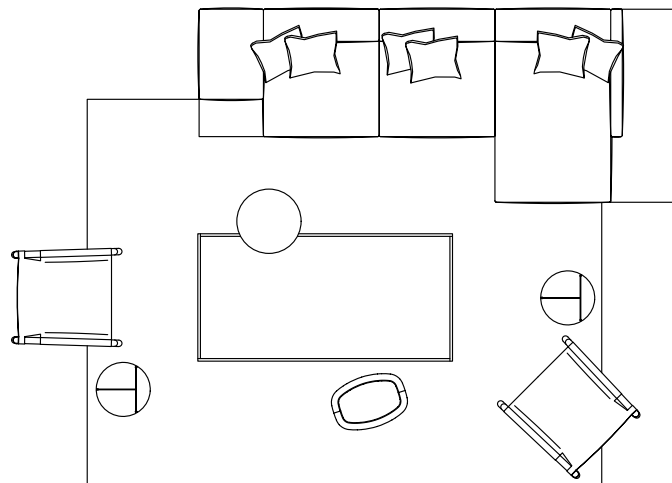

**Dock** - modular sofa / divano componibile  
DAL230TS\_3+DAL150LD\_1  
cover / rivestimento  
Salemi 2547220  
base / base  
0374C  
brushed light oak / rovere chiaro spazzolato  
support frame / struttura di sostegno  
0782S  
satin chromed steel / acciaio cromato satinato

**Dock** - small table / tavolino  
TDA198\_1  
0378G  
grey oak / rovere grigio  
support frame / struttura di sostegno  
0782S  
satin chromed steel / acciaio cromato satinato

**Spool** - small table / tavolino  
TSP40  
top and frame / piano e struttura  
6020L  
glossy smoke blue / smoke blue lucido

**Pablo** - armchair / poltrona  
PB77  
frame / struttura  
0374C  
brushed light oak / rovere chiaro spazzolato  
cover / rivestimento  
1136420  
embossed thick leather mud green / cuoio con grana verde fango

**Frank** - ottoman / pouf  
F58P  
cover / rivestimento  
Sirio 2053444

**Formiche** - small tables / tavolini  
FR42  
top / piano  
0200T  
transparent extra light glass / vetro extra light trasparente  
support frame / struttura di sostegno  
0259V  
pewter painted / verniciato petro

**Timo** - carpet / tappeto  
TMT4  
0022G  
grey / grigio

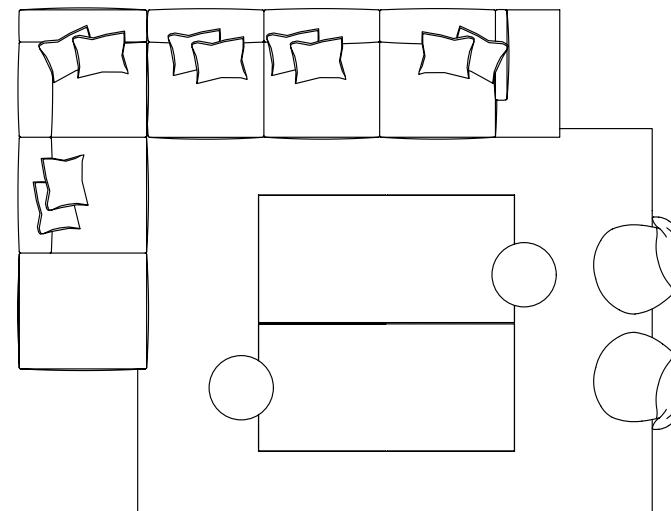

**Dock** - modular sofa / divano componibile  
DA320TD\_1+ DA279AD\_1  
cover / rivestimento  
Salemi 2547205  
base / base  
0378G  
grey oak / rovere grigio  
support frame / struttura di sostegno  
0782S  
satin chromed steel / acciaio cromato satinato

**Dock** - small table / tavolino  
TDA198\_2  
0378G  
grey oak / rovere grigio  
support frame / struttura di sostegno  
0782S  
satin chromed steel / acciaio cromato satinato

**Spool** - small table / tavolino  
TSP40  
top and frame / piano e struttura  
1346L  
glossy marsh brown / marrone palude lucido

**Piccola Papilio** - armchairs / poltrone  
PPA  
cover / rivestimento  
Gamma 1226420

**Istos** - carpet / tappeto  
TS4  
0017V green / verde

## Dock by Piero Lissoni

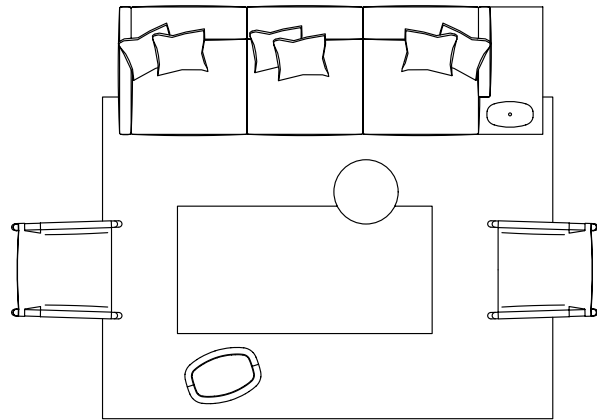

**Dock** - sofa / divano  
DA329D\_1  
cover / rivestimento  
Licata 2165340  
base / base  
0370F  
smoked oak / rovere fumigato  
support frame / struttura di sostegno  
0782S  
satin chromed steel / acciaio cromato satinato  
**Dock** - service element / elemento di servizio  
TD36  
top / piano  
0129F  
smoky glass / vetro fumè

**Dock** - small table / tavolino  
TDA198\_1  
0370F  
smoked oak / rovere fumigato  
support frame / struttura di sostegno  
0782S  
satin chromed steel / acciaio cromato satinato

**Pablo** - armchairs / poltrone  
PB77  
frame / struttura  
0370F  
smoked oak / rovere fumigato  
cover / rivestimento  
1136750  
embossed thick leather bordeaux /  
cuoio con grana bordeaux

**Spool** - small table / tavolino  
TSP40  
top and frame / piano e struttura  
1347L  
glossy khaki orange / arancio cachi lucido

**Frank** - ottoman / pouf  
F58P  
cover / rivestimento  
Sirio 205573

**Timo** - carpet / tappeto  
TMT4  
0022G  
grey / grigio

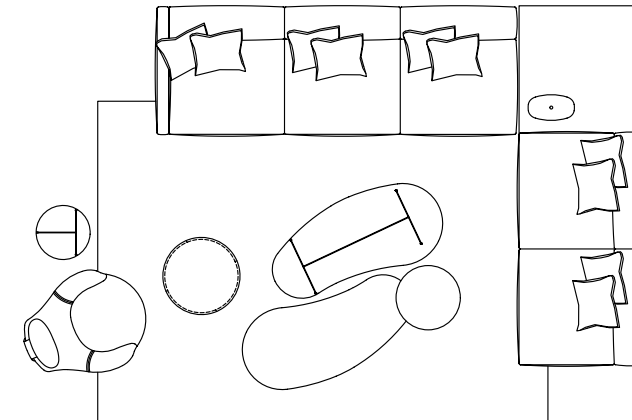

**Dock** - modular sofa / divano componibile  
DAL279TS+DAL279AS\_3  
cover / rivestimento  
Sapri 2480100  
base / base  
0356N  
canaletto walnut / noce canaletto  
support frame / struttura di sostegno  
0782S  
satin chromed steel / acciaio cromato satinato  
**Dock** - service element / elemento di servizio  
TD36  
top / piano  
0200T  
extra light transparent glass /  
vetro extra light trasparente

**Spool** - small table / tavolino  
TSP40  
top and frame / piano e struttura  
3738L  
glossy tortora / tortora lucido

**Harbor** - armchair and ottoman /  
poltrona e pouf  
HA80A+HA61P  
cover / rivestimento  
Serra 2025740

**Formiche** - small table / tavolino  
FR140\_1  
top / piano  
0200T  
transparent extra light glass /  
vetro extra light trasparente  
support frame / struttura di sostegno  
0259V  
painted pewter / verniciato petro

**Formiche** - small table / tavolino  
FR140\_1  
top / piano  
0301B  
Calacatta white porcelain stoneware /  
gres porcellanato bianco Calacatta  
support frame / struttura di sostegno  
0259V  
painted pewter / verniciato petro

**Formiche** - small table / tavolino  
FR42  
support frame / struttura di sostegno  
0259V  
painted pewter / verniciato petro  
top / piano  
0200T  
extra light transparent glass /  
vetro extra light trasparente

**Timo** - carpet / tappeto  
TMT3  
0022G  
grey / grigio

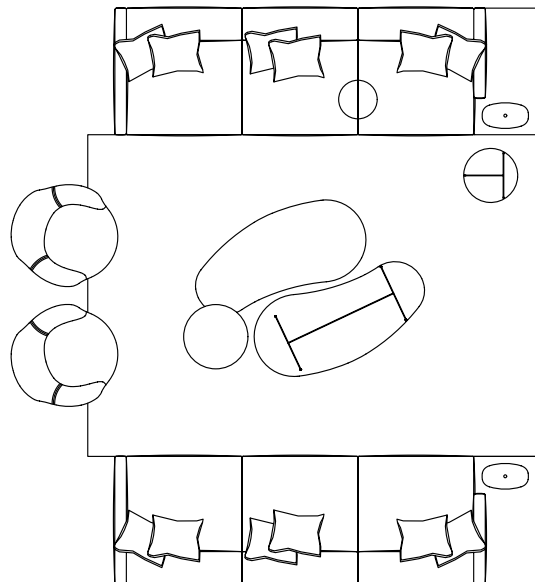

**Dock** - sofa / divano  
DAL329D\_1+DA31B  
cover / rivestimento  
Koto leather 1119280  
base / base  
0370F  
smoked oak / rovere fumigato  
support frame / struttura di sostegno  
0782S  
satin chromed steel / acciaio cromato satinato  
**Dock** - service element / elemento di servizio  
TD36  
top / piano  
0200T  
extra light transparent glass /  
vetro extra light trasparente

**Dock** - sofa / divano  
DAL329S\_1  
cover / rivestimento  
Salemi 2547205  
base / base  
0370F  
smoked oak  
rovere fumigato  
support frame / struttura di sostegno  
0782S  
satin chromed steel / acciaio cromato satinato  
**Dock** - service element / elemento di servizio  
TD36  
top / piano  
0200T  
extra light transparent glass /  
vetro extra light trasparente

**Dock** - service element / elemento di servizio  
TD36  
top / piano  
0200T  
extra light transparent glass /  
vetro extra light trasparente

**Spool** - small table / tavolino  
TSP40  
top and frame / piano e struttura  
3750L  
glossy coffee / caffè lucido

**Harbor** - armchairs / poltrone  
HA80B  
cover / rivestimento  
Elmas 2444375

**Formiche** - small table / tavolino  
FR140\_1  
top / piano  
0200T  
transparent extra light glass /  
vetro extra light trasparente  
support frame / struttura di sostegno  
0259V  
painted pewter / verniciato petro

**Formiche** - small table / tavolino  
FR140\_1  
top / piano  
0301B  
Calacatta white porcelain stoneware /  
gres porcellanato bianco Calacatta  
support frame / struttura di sostegno  
0259V  
painted pewter / verniciato petro

**Formiche** - small table / tavolino  
FR42  
support frame / struttura di sostegno  
0259V  
painted pewter / verniciato petro  
top / piano  
0200T  
extra light transparent glass /  
vetro extra light trasparente

**Timo** - carpet / tappeto  
TMT3  
0022G  
grey / grigio

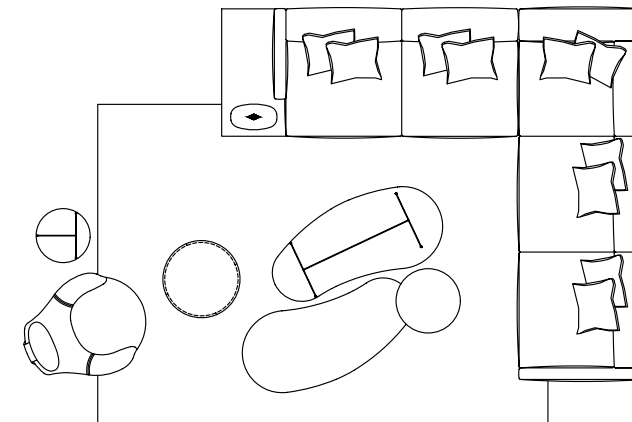

**Dock** - modular sofa / divano componibile  
DAL230TS\_1+DAL288AS  
cover / rivestimento  
Sapri 2480100  
base / base  
0356N  
canaletto walnut / noce canaletto  
support frame / struttura di sostegno  
0782S  
satin chromed steel / acciaio cromato satinato  
**Dock** - service element / elemento di servizio  
TD36  
top / piano  
0200T  
extra light transparent glass /  
vetro extra light trasparente

**Spool** - small table / tavolino  
TSP40  
top and frame / piano e struttura  
3738L  
glossy tortora / tortora lucido

**Harbor** - armchair and ottoman /  
poltrona e pouf  
HA80A+HA61P  
cover / rivestimento  
Serra 2025740

**Formiche** - small table / tavolino  
FR140\_1  
top / piano  
0200T  
transparent extra light glass /  
vetro extra light trasparente  
support frame / struttura di sostegno  
0259V  
painted pewter / verniciato petro

**Formiche** - small table / tavolino  
FR140\_1  
top / piano  
0301B  
Calacatta white porcelain stoneware /  
gres porcellanato bianco Calacatta/  
support frame / struttura di sostegno  
0259V  
painted pewter / verniciato petro

**Formiche** - small table / tavolino  
FR42  
support frame / struttura di sostegno  
0259V  
painted pewter / verniciato petro  
top / piano  
0200T  
extra light transparent glass /  
vetro extra light trasparente

**Timo** - carpet / tappeto  
TMT3  
0022G  
grey / grigio



# Pablo by Vincent Van Duysen

PB77

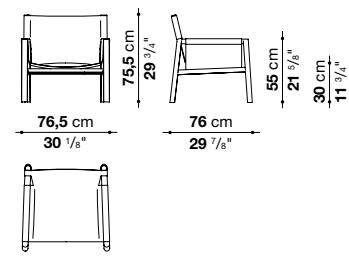

Frame	solid wood
Internal shell	Bayfit® flexible cold shaped polyurethane foam and glass fibre
Ferrules	felt
Cover	thick leather

Struttura	legno massello
Scocca interna	schiuma di poliuretano flessibile a freddo Bayfit® e vetroresina
Puntali	feltro
Rivestimento	cuoio

Cover (thick leather or embossed thick leather)  
Rivestimento (cuoio o cuoio con grana)

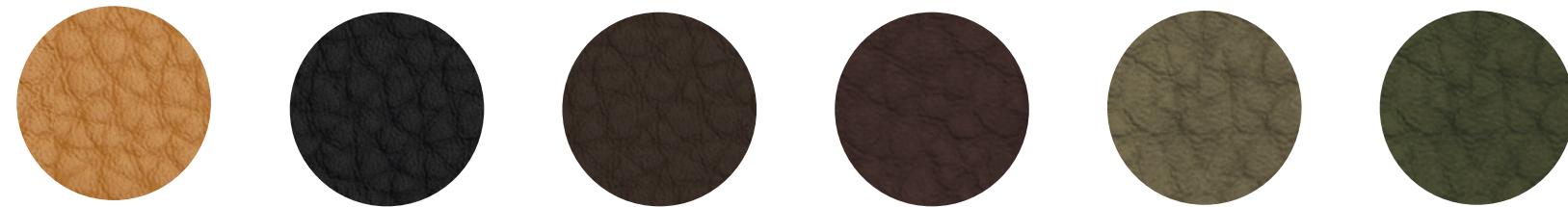

1136100 natural naturale  
1136150 black nero  
1136350 dark brown testa di moro  
1136750 bordeaux bordeaux  
1136420 mud green verde fango  
1136400 bottle green verde bottiglia

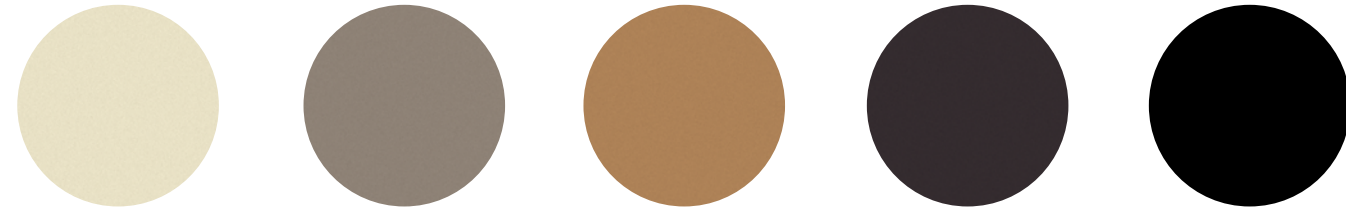

1121201 ivory avorio  
1121280 tortora tortora  
1121300 natural naturale  
1121350 dark brown testa di moro  
1121150 black nero

Frame  
Struttura



0374C brushed light oak rovere chiaro spazzolato  
0378G grey oak rovere grigio  
0381N brushed black oak rovere nero spazzolato  
0394T smoked stained oak rovere tinto umigato  
0356N canaletto walnut noce canaletto

# Jack by Michael Anastassiades

DIMENSIONS OF VERTICAL DEVELOPMENT - CEILING FIXING  
 DIMENSIONI SVILUPPO VERTICALE - FISSAGGIO A SOFFITTO

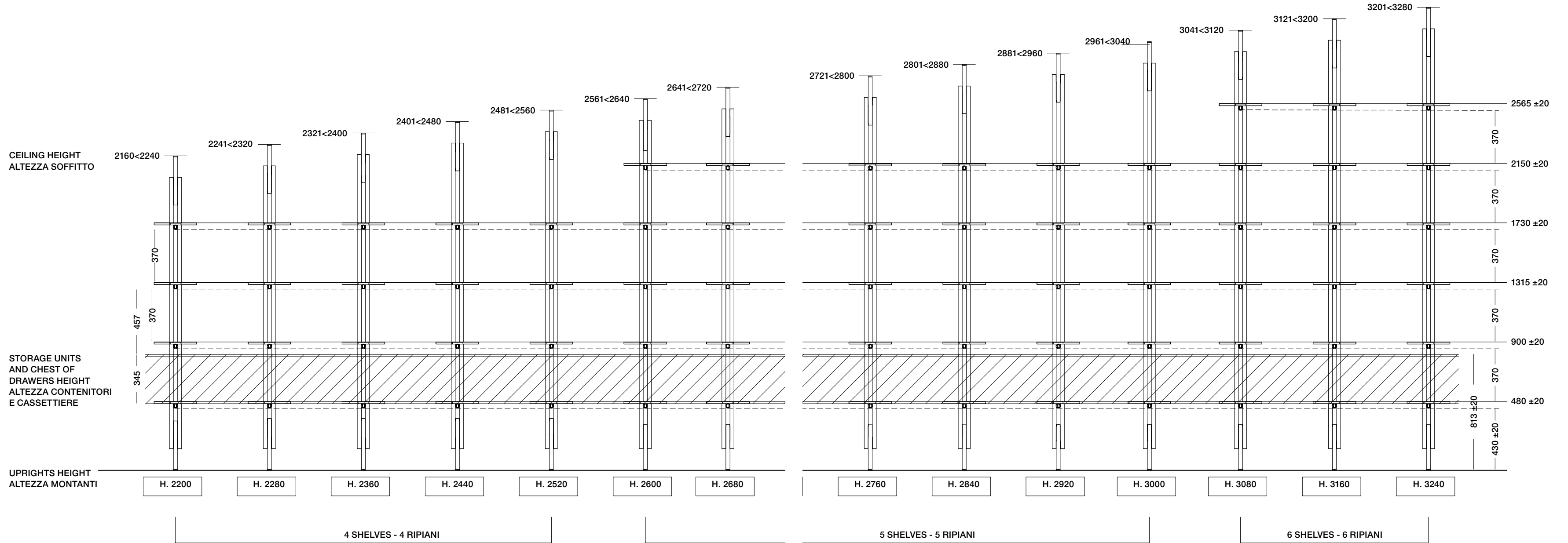



# Jack by Michael Anastassiades

DIMENSIONS OF VERTICAL DEVELOPMENT - WALL FIXING  
 DIMENSIONI SVILUPPO VERTICALE - FISSAGGIO A MURO

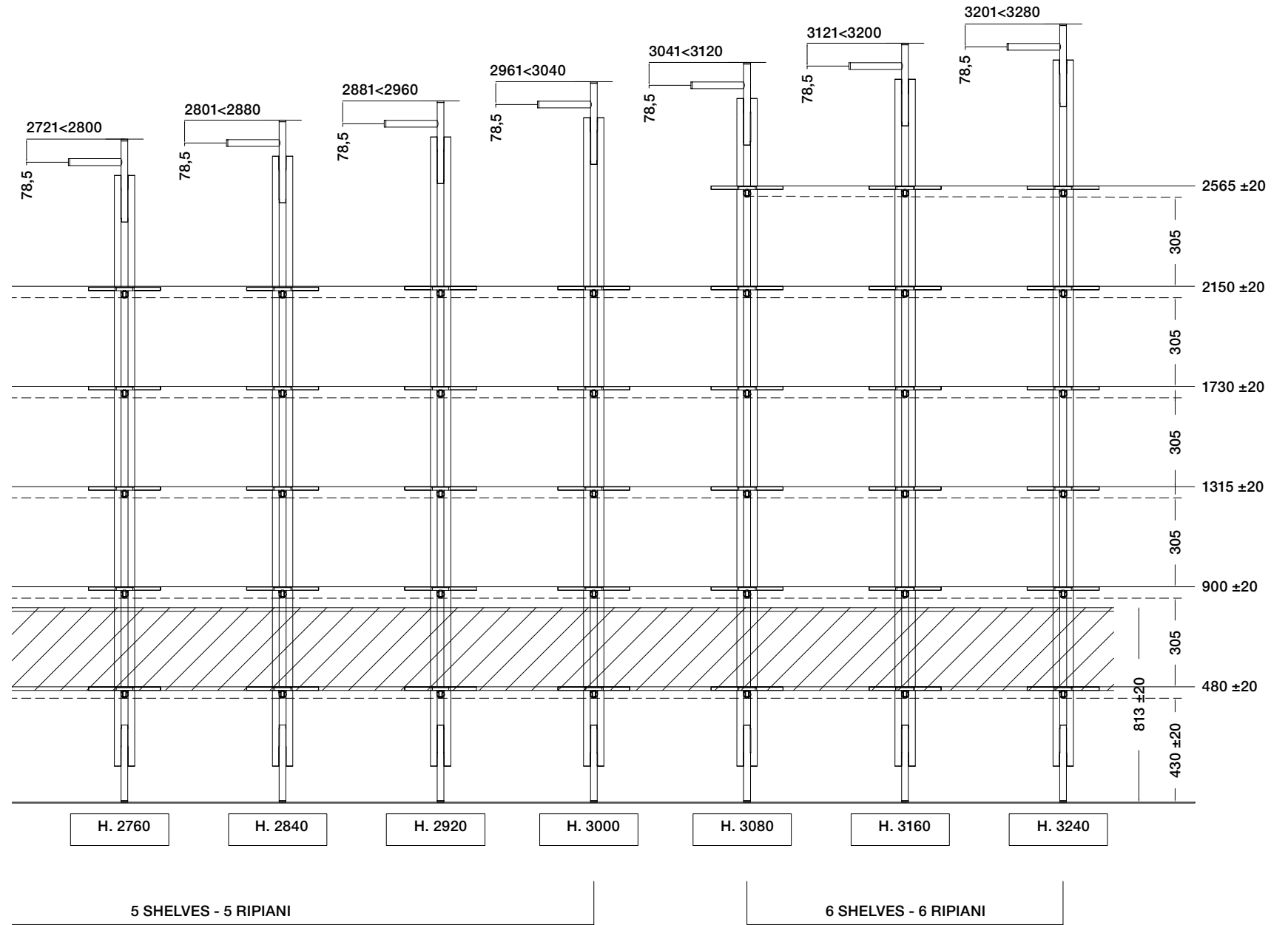
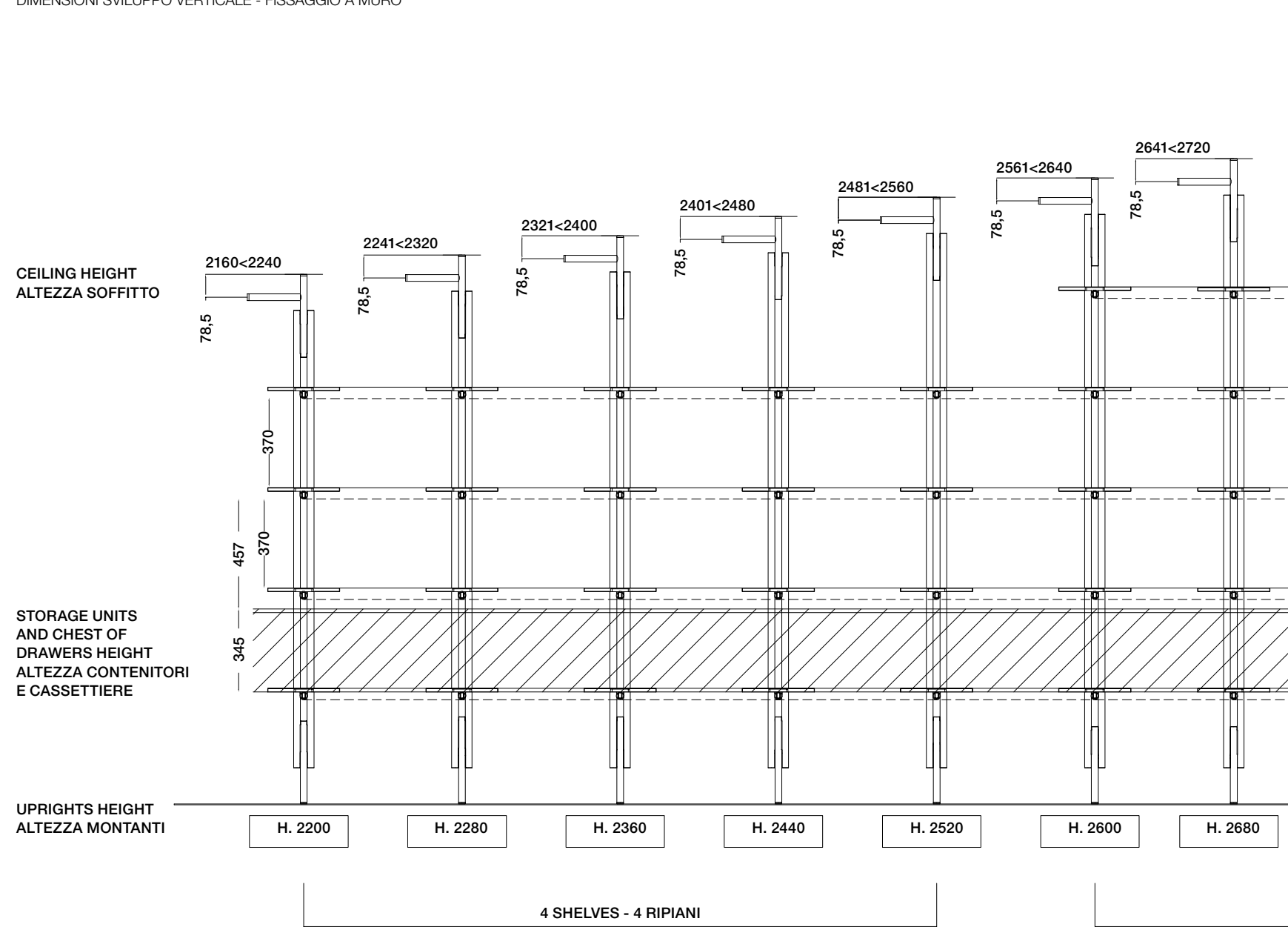

# Jack by Michael Anastassiades

## DIMENSIONS OF VERTICAL DEVELOPMENT DIMENSIONI SVILUPPO VERTICALE

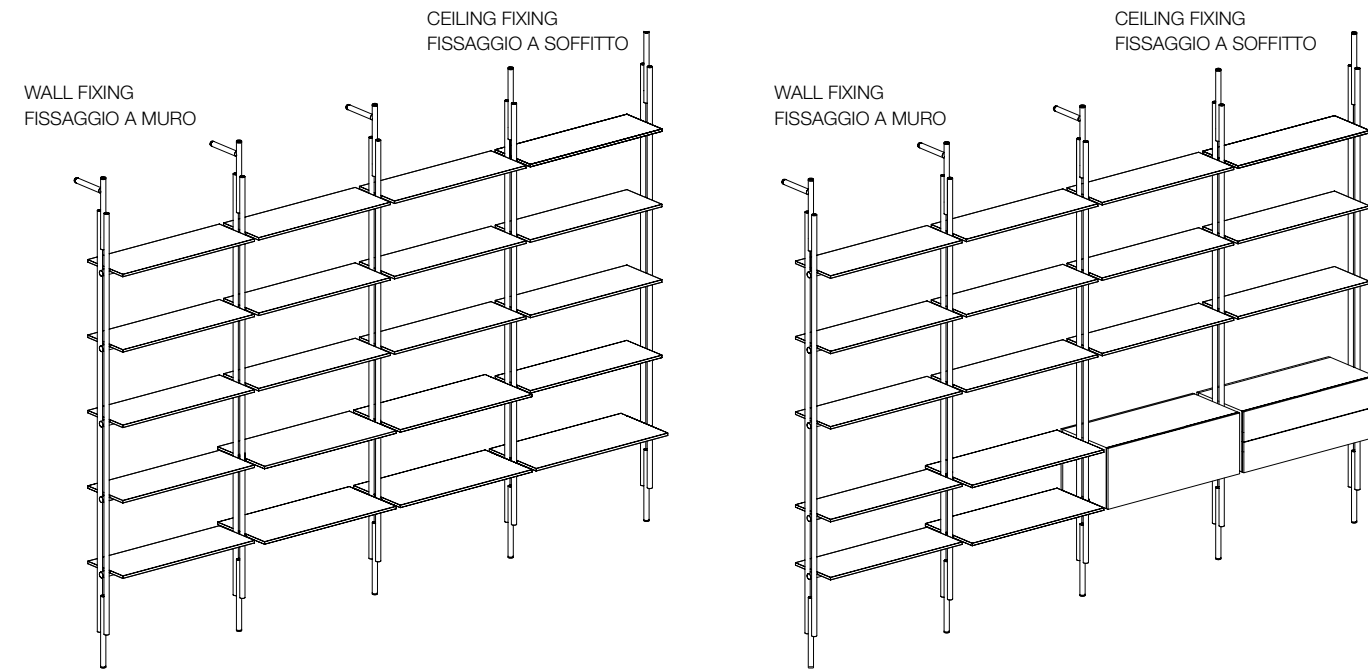

## STORAGE UNITS COMPOSITION HEIGHT ALTEZZA COMPOSIZIONE CONTENITORI

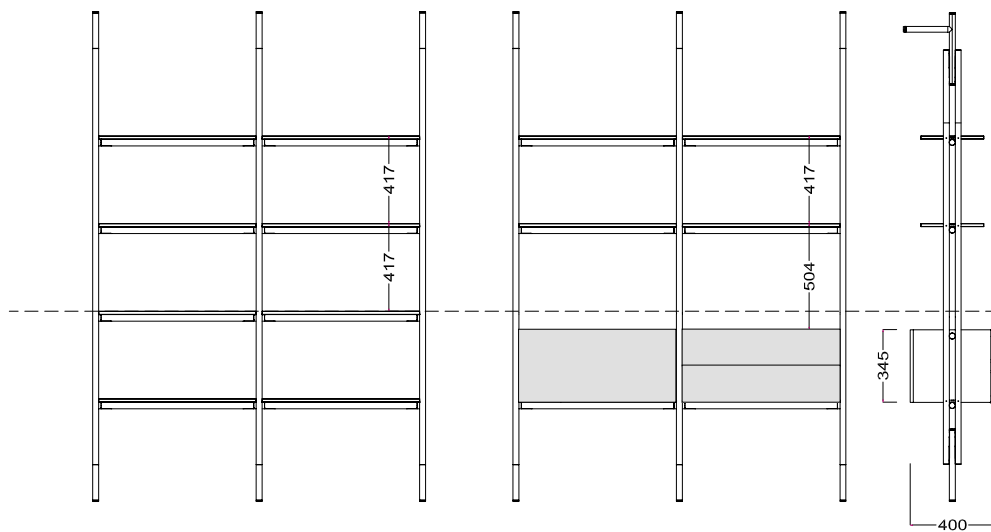

## STORAGE UNITS CONTENITORI

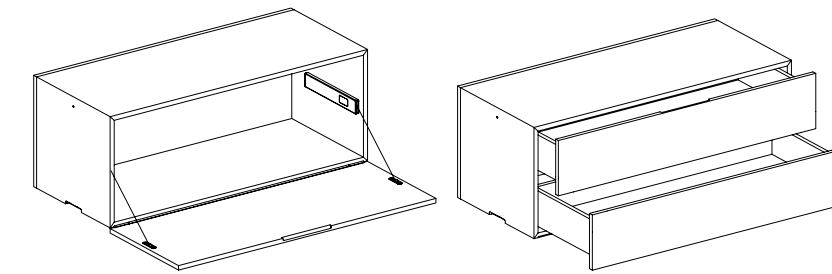

FLAP DOOR / ANTA A RIBALTA  
750 X 400 X H.345 MM  
900 X 400 X H.345 MM

DRAWERS / CASSETTI  
750 X 400 X H.345 MM  
900 X 400 X H.345 MM

## SHELVES RIPIANI

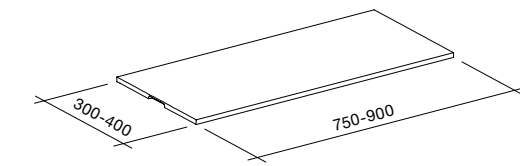

SHELVES DEPHT 300-400 MM  
RIPIANI PROFONDITÀ 300-400 MM

Uprights	aluminum
Shelves	HPL laminate or solid wood
Storage units	HPL laminate or solid wood

Montanti	alluminio
Ripiani	laminato HPL o legno massello
Contenitori	laminato HPL o legno massello

## Shelves and storage units Ripiani e contenitori



0374C  
brushed light oak  
rovere chiaro spazzolato



0378G  
grey oak  
rovere grigio



0381N  
brushed black oak  
rovere nero spazzolato



0370F  
smoked oak  
rovere fumigato



0356N  
canaletto walnut  
noce canaletto

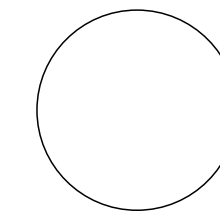

9118E  
satin chalk white  
bianco gesso satinato

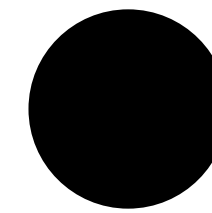

3764E  
satin black  
nero satinato

## Uprights Montanti

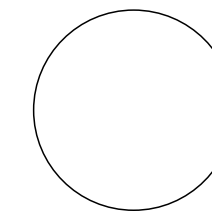

9118E  
satin chalk white  
bianco gesso satinato

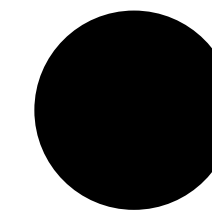

3764E  
satin black  
nero satinato



# Parallel Structure by Michael Anastassiades

PS28V

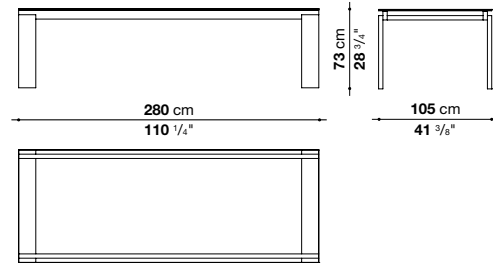

PS23V

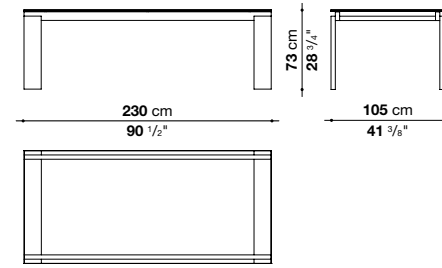

PS28

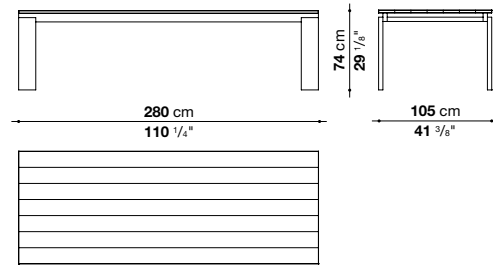

PS23

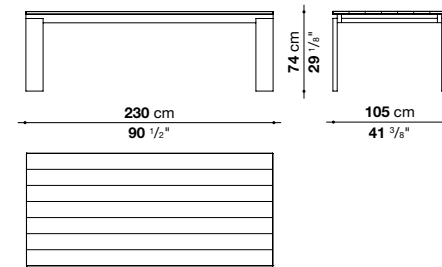

<b>Top</b>	solid wood, veneered wood particles panel or glass
<b>Frame</b>	solid wood
<b>Support crosspieces</b>	drawn aluminium
<b>Ferrules</b>	felt

<b>Piano</b>	legno massello, pannello in particelle di legno impiallacciato o vetro
<b>Struttura</b>	legno massello
<b>Traverse di sostegno</b>	trafilati d'alluminio
<b>Puntali</b>	feltro

## Frame Struttura



0374C  
brushed light oak  
rovere chiaro spazzolato



0378G  
grey oak  
rovere grigio



0381N  
brushed black oak  
rovere nero spazzolato



0370F  
smoked oak  
rovere fumigato



0356N  
canaletto walnut  
noce canaletto

## Top Piano



0374C  
brushed light oak  
rovere chiaro spazzolato



0378G  
grey oak  
rovere grigio



0381N  
brushed black oak  
rovere nero spazzolato



0370F  
smoked oak  
rovere fumigato



0356N  
canaletto walnut  
noce canaletto

## Glas top (PS28V-PS23V) Piano in vetro

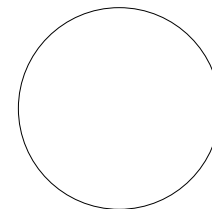

0200T  
transparent extra light glass  
vetro extra light trasparente

## Support crosspieces Traverse di sostegno

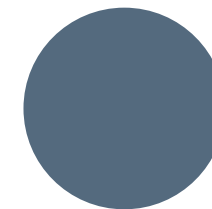

0084B  
blue painted  
verniciato blu

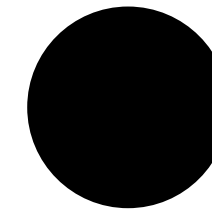

0096N  
black painted  
verniciato nero

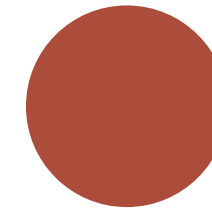

0076R  
red painted  
verniciato rosso

## Bull by Naoto Fukasawa

### TBU110

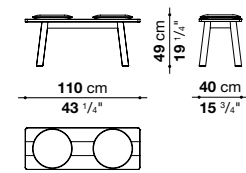

### TBU190

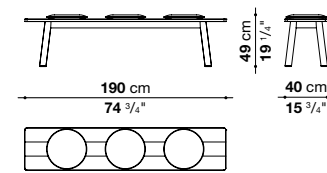

<b>Top</b>	solid wood, veneered wood particles panel
<b>Frame</b>	solid wood
<b>Support crosspieces</b>	steel
<b>Feet</b>	plastic material
<b>Cushion</b>	shaped polyurethane, polyester fibre
<b>Cushion cover</b>	fabric or leather

<b>Piano</b>	legno massello, pannello in particelle di legno impiallacciato
<b>Struttura</b>	legno massello
<b>Traverse di sostegno</b>	acciaio
<b>Piedini</b>	materiale plastico
<b>Cuscino</b>	poliuretano sagomato, fibra di poliestere
<b>Rivestimento cuscino</b>	tessuto o pelle

### Frame Struttura



0374C  
brushed light oak  
rovere chiaro spazzolato



0378G  
grey oak  
rovere grigio



0381N  
brushed black oak  
rovere nero spazzolato



0394T  
stained smoked oak  
rovere tinto fumigato

### Top Piano



0374C  
brushed light oak  
rovere chiaro spazzolato



0378G  
grey oak  
rovere grigio



0381N  
brushed black oak  
rovere nero spazzolato



0370F  
smoked oak  
rovere fumigato

## Papilio by Naoto Fukasawa

### SP51A

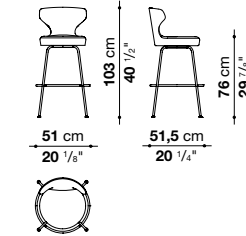

### SP51B

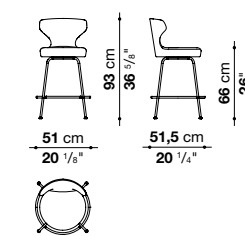

<b>Internal frame</b>	thermoplastic material shell
<b>Internal frame upholstery</b>	Bayfit® flexible cold shaped polyurethane foam, polyester fibre cover
<b>Legs</b>	tubular steel and steel profiles
<b>Ferrules</b>	thermoplastic material
<b>Cover</b>	fabric or leather in limited categories

<b>Telaio interno</b>	scocca in materiale termoplastico
<b>Imbottitura telaio interno</b>	schiuma di poliuretano flessibile a freddo Bayfit®, fodera in fibra di poliestere
<b>Gambe</b>	tubi e profilati d'acciaio
<b>Puntali</b>	materiale termoplastico
<b>Rivestimento</b>	tessuto o pelle in categorie limitate

### Legs Gambe

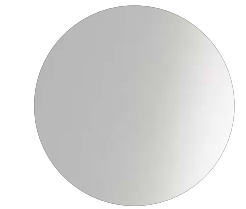

0110M  
bright chromed  
cromato lucido

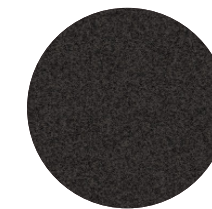

0178C  
black chromed  
cromato nero

### Cover Rivestimento

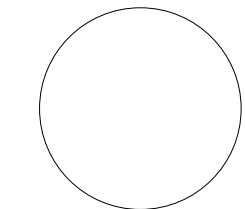

fabric or leather  
in limited categories /  
tessuto o pelle  
in categorie limitate



SJ41L\_A

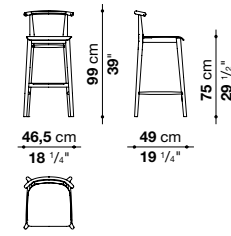

SJ41L\_B

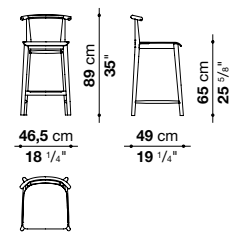

SJ41PA\_A

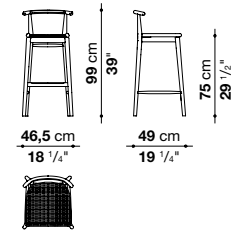

SJ41PA\_B

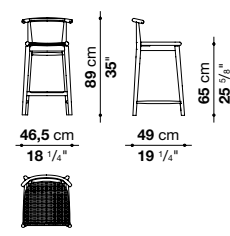

Seat (SJ41L)	shaped polyurethane and veneered multi-layered wood panel
Seat (SJ41PA)	cellulose rope interlacing
Frame	solid wood
Ferrules and reinforcements	plastic material

Seduta (SJ41L)	poliuretano sagomato e pannello in multistrato di legno impiallacciato
Seduta (SJ41PA)	intreccio in corda di cellulosa
Struttura	legno massello
Puntali e rinforzi	materiale plastico

Frame and seat matching  
Abbinamento struttura e seduta

Seat  
Seduta

Frame  
Struttura

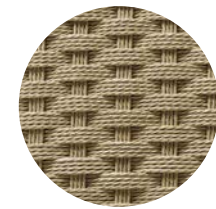

0601N  
natural cellulose rope  
corda di cellulosa naturale

0374C  
brushed light oak  
rovere chiaro spazzolato

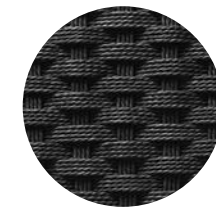

0650N  
black cellulose rope  
corda di cellulosa nera

0378G  
grey oak  
rovere grigio



0381N  
brushed black oak  
rovere nero spazzolato



0394T  
smoked stained oak  
rovere tinto fumigato



0414W  
natural wenge  
wengé naturale

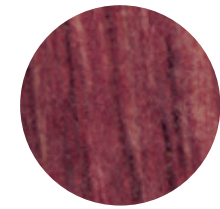

0361A  
amaranth stained oak  
rovere tinto amaranto

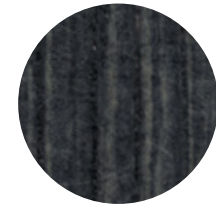

0330B  
blue stained oak  
rovere tinto blu

For the specific finishes matched at each product code, please refer to the relevant price list notes.  
Per le finiture specifiche associate ad ogni singolo codice prodotto, fare riferimento alle relative note del listino prezzi.

PN180\_1

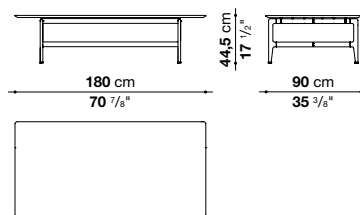

PN180\_2

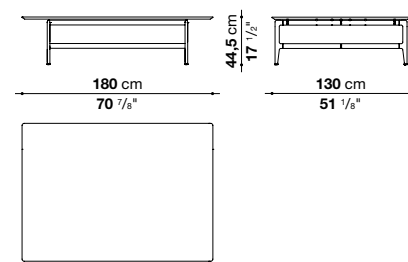

PN130Q

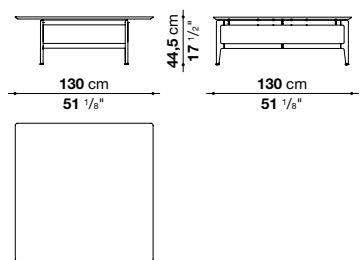

PN130

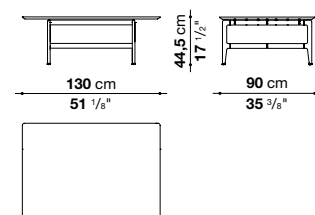

PN180\_2V

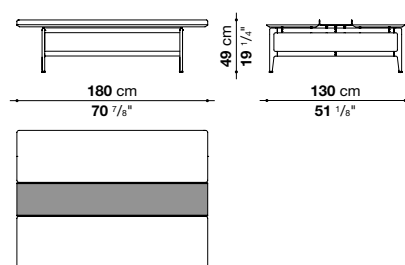

PN130Q\_V

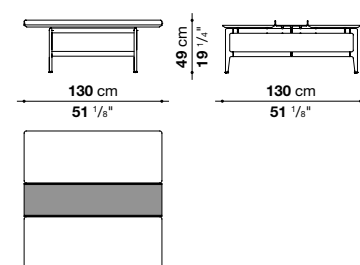

<b>Top</b>	marble or veneered multi-layered wood panel
<b>Tray (PN180_2V-PN130Q_V)</b>	aluminium sheet covered in thick leather
<b>Support frame</b>	die-cast aluminium and extrusions
<b>Ferrules</b>	plastic material

<b>Piano</b>	marmo o pannello in multistrato di legno impiallacciato
<b>Vassoio (PN180_2V-PN130Q_V)</b>	lamiera d'alluminio rivestito cuoio
<b>Struttura di sostegno</b>	fusione ed estrusi d'alluminio
<b>Puntali</b>	materiale plastico

**Support frame**  
Struttura di sostegno

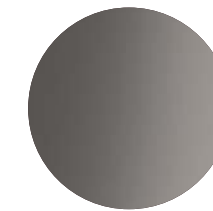

0259V  
pewter painted  
verniciato peltro

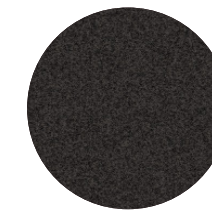

0170M  
painted black chrome  
verniciato cromato nero

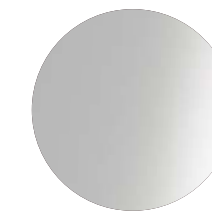

0189A  
bright brushed  
spazzolato lucido

**Wooden top**  
Piano in legno



0374C  
brushed light oak  
rovere chiaro spazzolato



0378G  
grey oak  
rovere grigio



0381N  
brushed black oak  
rovere nero spazzolato



0370F  
smoked oak  
rovere fumigato

**Marble top**  
Piano in marmo



0955M  
matt Marquina  
black marble  
marmo nero  
Marquina opaco

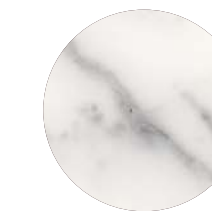

0890M  
matt Carrara white marble  
"venatino statuario"  
marmo bianco Carrara  
"venatino statuario" opaco

**Thick leather or embossed thick leather tray (PN180\_2V - PN130Q\_V)**  
Vassoio in cuoio o cuoio con grana

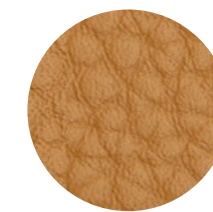

1136100  
natural  
naturale

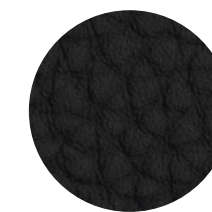

1136150  
black  
nero

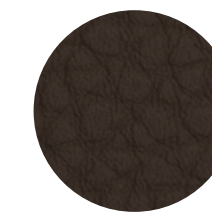

1136350  
dark brown  
testa di moro



1136750  
bordeaux  
bordeaux

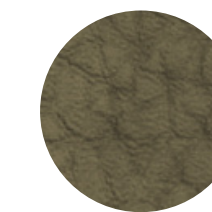

1136420  
mud green  
verde fango

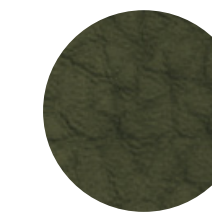

1136400  
bottle green  
verde bottiglia



1121201  
ivory  
avorio

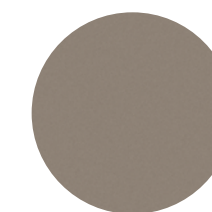

1121280  
tortora  
tortora

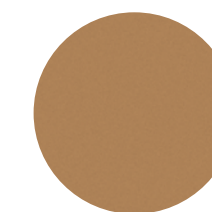

1121300  
natural  
naturale

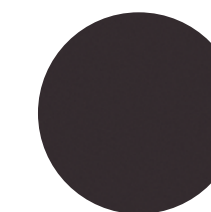

1121350  
dark brown  
testa di moro

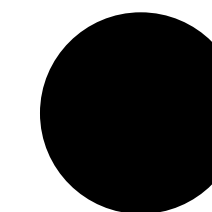

1121150  
black  
nero



**Diesis 40** by Antonio Citterio and Paolo Nava

**40D277**

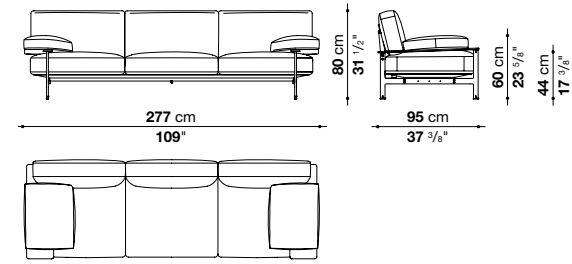

**40D135LS**

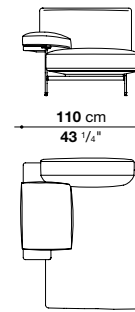

**40D135LD**

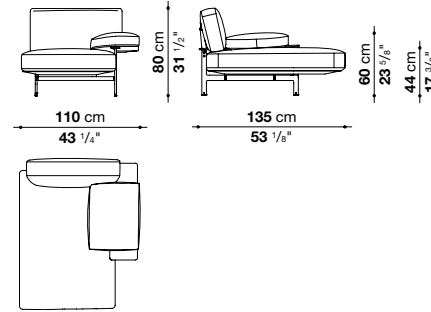

**40D203P**

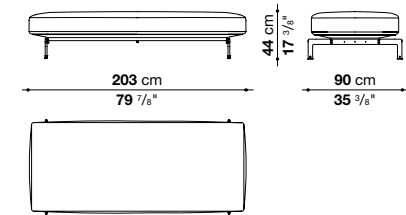

**40TD150**

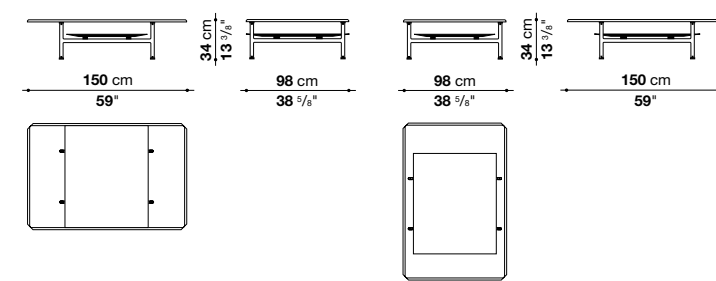

<b>Frame</b>	steel sheet and steel profiles covered in Saffiano thick leather
<b>Seat cushion upholstery</b>	shaped polyurethane of different density, sterilized down, polyurethane inserts, polyester fibre cover
<b>Back and armrest cushion upholstery</b>	sterilized down, polyurethane inserts
<b>Top (40TD150)</b>	glass
<b>Lower shelf (40TD150)</b>	multi-layered wood panel
<b>Lower shelf cover (40TD150)</b>	Saffiano thick leather
<b>Support frame and feet</b>	die-cast aluminium and tubular steel
<b>Ferrules</b>	plastic material
<b>Cover</b>	leather in limited categories

<b>Struttura</b>	lamiera e profilati d'acciaio rivestita in cuoio Saffiano
<b>Imbottitura cuscino sedile</b>	poliuretano sagomato a densità differenziata, piuma sterilizzata, lastrine di poliuretano, fodera in fibra di poliestere
<b>Imbottitura cuscino schienale e bracciolo</b>	piuma sterilizzata, lastrine di poliuretano
<b>Piano (40TD150)</b>	vetro
<b>Sottopiano (40TD150)</b>	pannello in multistrato di legno
<b>Rivestimento sottopiano (40TD150)</b>	cuoio Saffiano
<b>Struttura di sostegno e piedini</b>	fusione d'alluminio e tubolari d'acciaio
<b>Puntali</b>	materiale plastico
<b>Rivestimento</b>	pelle in categorie limitate

Frame cover, cushions cover and eco-leather profiles matching  
Abbinamenti rivestimento struttura, rivestimento cuscini e profili in ecopelle

**Frame cover**  
Rivestimento struttura

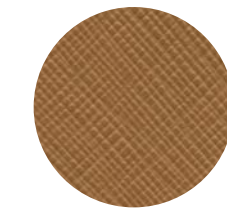

1144300  
natural Saffiano thick leather  
cuoio Saffiano naturale

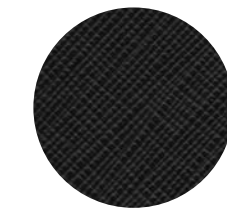

1144150  
black Saffiano thick leather  
cuoio Saffiano nero

**Frame**  
**Struttura**

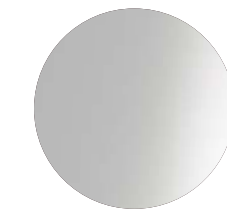

0189A  
bright brushed  
spazzolato lucido

**Cushions cover**  
Rivestimento cuscini

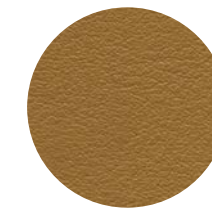

1229300  
natural Kos leather  
pelle Kos naturale

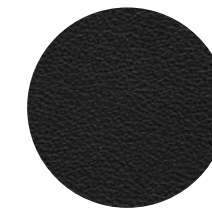

1229150  
black Kos leather  
pelle Kos nero

**Profiles**  
Profili

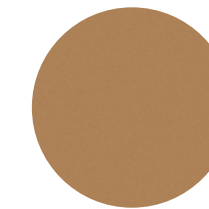

1130106  
natural eco-leather  
ecopelle naturale

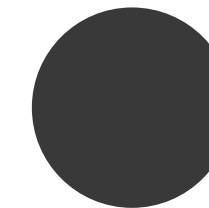

1130150  
black eco-leather  
ecopelle nero

**Top (40TD150)**  
**Piano**

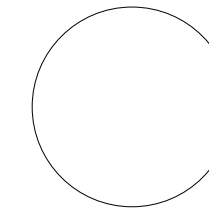

0117T  
transparent glass  
vetro trasparente

**Lower shelf (40TD150)**  
**Sottopiano**

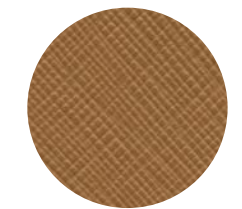

1144300  
natural Saffiano thick leather  
cuoio Saffiano naturale

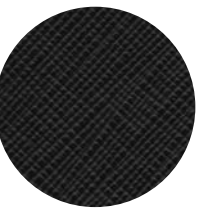

1144150  
black Saffiano thick leather  
cuoio Saffiano nero

# Up 50 by Gaetano Pesce

## 50UP5\_6

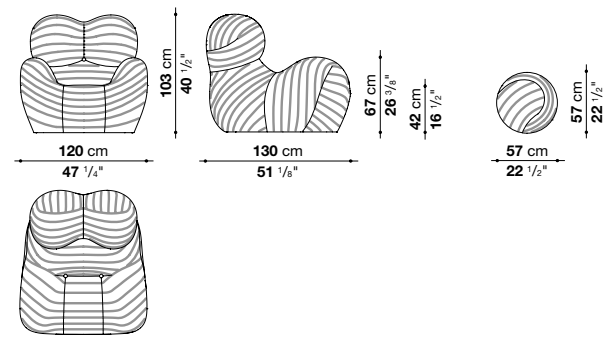

## 50UP5\_6B

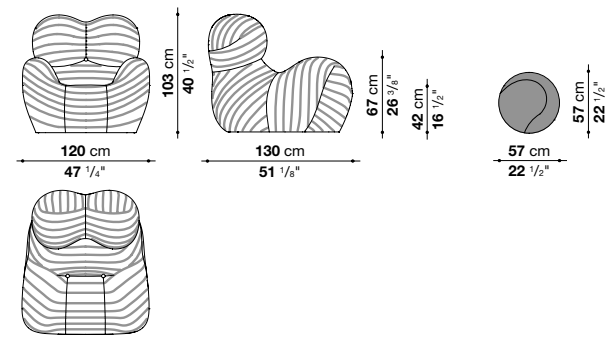

<b>Upholstery</b>	Bayfit® flexible cold shaped polyurethane foam
<b>Bottom base</b>	100% jute fabric, PVC trimming
<b>Cover button</b>	metallic base and fabric
<b>Bottom base button</b>	thick leather
<b>Cover</b>	fabric in limited categories

<b>Imbottitura</b>	schiuma di poliuretano flessibile a freddo Bayfit®
<b>Fondo</b>	tessuto 100% iuta, guarnizione in PVC
<b>Rivestimento bottone</b>	base metallica e tessuto
<b>Bottone fondo</b>	cuoio
<b>Rivestimento</b>	tessuto in categorie limitate

Armchair cover (50UP5\_6B)  
Rivestimento poltrona

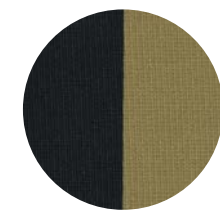

Soara 2109140

Ottoman cover  
Rivestimento pouf

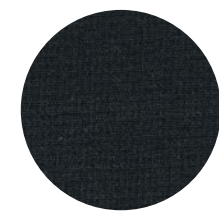

Soara 2163420

Armchair and ottoman cover (50UP5\_6)  
Rivestimento poltrona e pouf

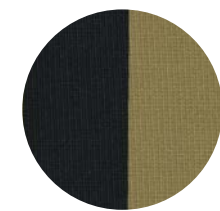

Soara 2109140

# Riso by Juma

## RST\_cut to size - taglio a misura

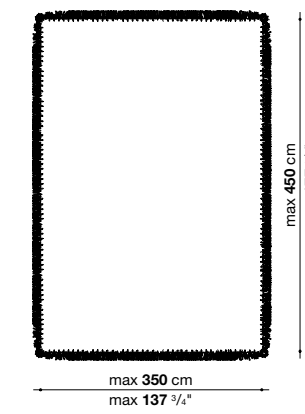

## RS2T

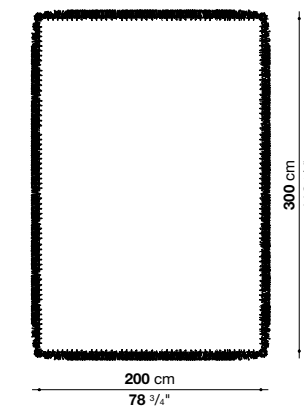

## RS3T

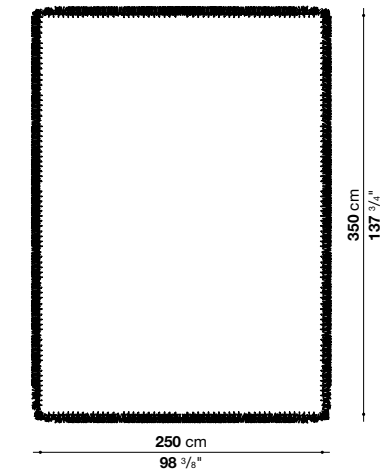

## RS4T

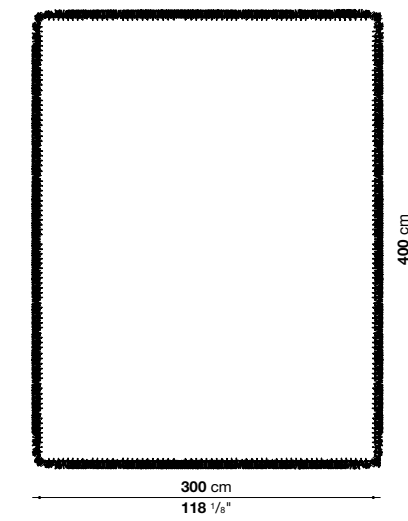

Composition 100% wool

Composizione 100% lana

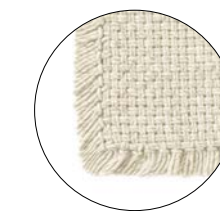

0027C  
light  
luce

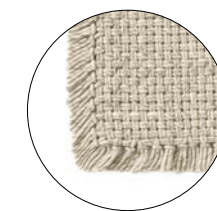

0034D  
desert  
deserto

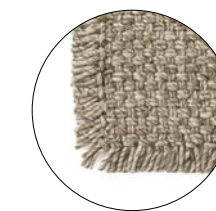

0071G  
soil  
terra

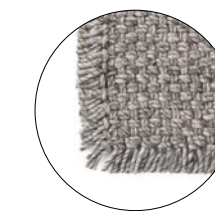

0051G  
shadow  
ombra



0078A  
night  
notte

The carpets are hand-made. Due to that, dimensions might not be totally exact, variations in dimensions +/- 3 cm on each side fringes excluded.  
I tappeti sono realizzati a mano. Per questo motivo le dimensioni potrebbero non essere totalmente esatte, Variazione dimensionale di +/- 3 cm su entrambi i lati, frange escluse



MLT \_ cut to size - taglio a misura

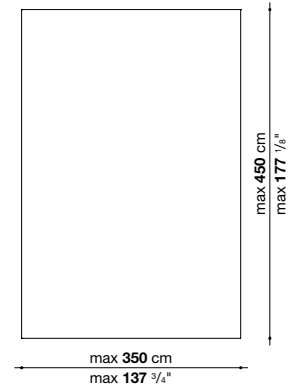

ML2T

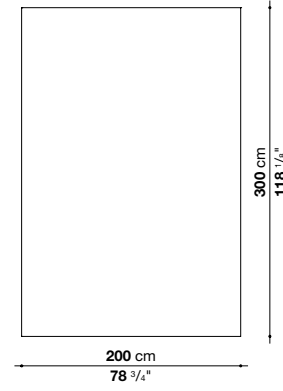

ML3T

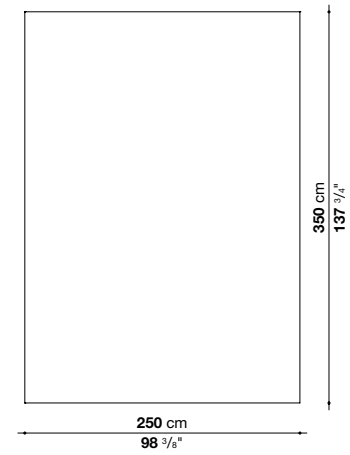

ML4T

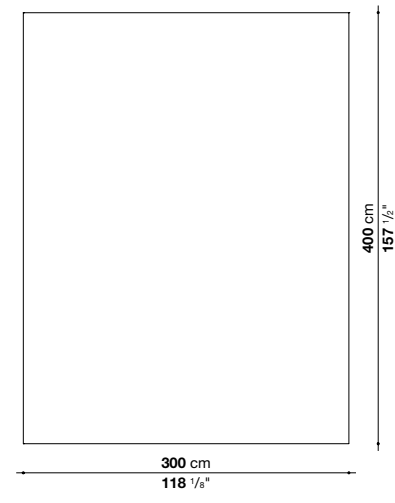

Composition 100% wool

Composizione 100% lana



0134Q quartz

0217G graphite

The carpets are hand-made. Due to that, dimensions might not be totally exact, variations in dimensions +/- 3 cm on each side. I tappeti sono realizzati a mano. Per questo motivo le dimensioni potrebbero non essere totalmente esatte, Variazione dimensionale di +/- 3 cm su entrambi i lati.

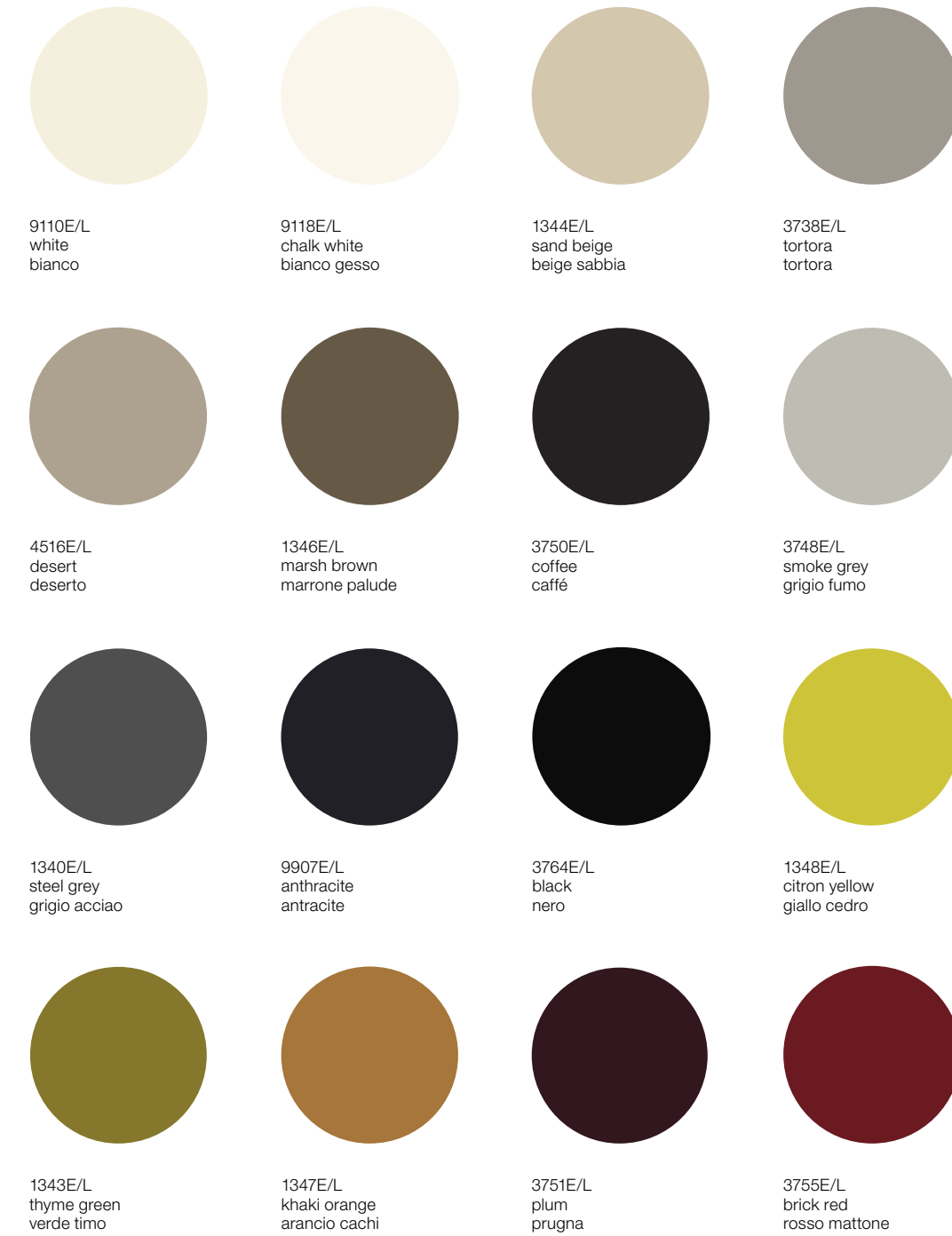

The colours and materials shades reproduced on paper in as an indication. La tonalità dei colori e dei materiali riprodotta su carta ha un valore indicativo.

## Contacts, Contatti



### B&B ITALIA SPA

22060 Novedrate (CO) Italy  
Strada Provinciale 32  
T. + 39 031 795 111  
F. + 39 031 791 592

www.bebitalia.com  
www.maxalto.it

Info: info@bebitalia.com

Italia  
numero verde 800 018 370  
USA  
toll free number 800 872 1697

All other countries

T. + 39 031 795 213  
F. + 39 031 791 592

### B&B ITALIA STORES

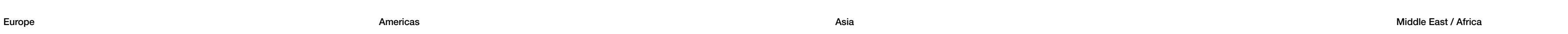

Europe	Americas	Asia	Middle East / Africa
--------	----------	------	----------------------

<b>B&amp;B Italia Milano</b> Via Durini 14, Milano T. 02 76 44 41 store.milano@bebitalia.it	<b>B&amp;B Italia Wien</b> Franz-Josefs-Kai 45 1010 Wien T. +43 (0) 1 533 55 00 Info@bebitalia-wien.at	<b>B&amp;B Italia New York</b> 150 East 58th Street New York, NY 10155 T. 212 758 4046 info.usa@bebitalia.com	<b>B&amp;B Italia Seattle</b> 1300 Western Avenue Seattle, WA 98101 T. 206 287 9992 seattle@divafurniture.com
--	--	---	---

<b>B&amp;B Italia Genova</b> Via Macaggi 41 R, 16121 Genova T. 010 8446734 bebitalia@fedesign.it http://genova.bebitalia.it	<b>B&amp;B Italia Athens</b> 358 Kifisias Ave 15233 Chalandri Athens Greece T. +30.2106847720 info@deloudis.gr	<b>B&amp;B Italia Madison Avenue</b> 135 Madison Avenue New York, NY 10016 T. +1 212 889 9606 info.usa@bebitalia.com	<b>B&amp;B Italia Sun Valley</b> 110 Lindsay Cir, Ketchum, ID 83340 T. +1.208.928.6379 - rob@arsunvalley.com
--	---	--	--

<b>B&amp;B Italia London</b> 250 Brompton Road London SW3 2AS T. 020 7591 8111 store.london@bebitalia.it	<b>B&amp;B Italia Cyprus</b> 50 Limassol Avenue 2014 Nicosia Tel. +357.22250700 marketing@ergohomegroup.com	<b>B&amp;B Italia Washington DC</b> 3320 M Street Northwest Washington DC 20007 T. 202 337 7700 info.usa@bebitalia.com	<b>B&amp;B Italia Mexico City</b> -B&B Italia Mexico City Avenida Presidente Masaryk 275 Polanco, 11550, Miguel Hidalgo Ciudad De Mexico T. +52 5552815551 bebitalia@piso18.com
--	---	--	---

<b>B&amp;B Italia Paris</b> 35, Rue du Bac 75007 Paris T. 01 55 35 14 35 info@bebitalia.fr	<b>B&amp;B Italia Los Angeles</b> 8801 Beverly Boulevard Los Angeles, CA 90048 T. 310 278 3191 info@divafurniture.com	<b>B&amp;B Italia Sao Paulo</b> Avenida Brasil 1653 Jardim America CEP: 01431-001 São Paulo (SP) Brasil T. +55 11 3368-6033 contato@casualmoveis.com.br	<b>B&amp;B Italia Mexico City</b> -B&B Italia Mexico City Avenida Presidente Masaryk 275 Polanco, 11550, Miguel Hidalgo Ciudad De Mexico T. +52 5552815551 bebitalia@piso18.com
--	---	---	---

<b>B&amp;B Italia Saint-Tropez</b> Avenue Maréchal Foch quartier Saint Roch 83992 Saint-Tropez T. +33.494457720 contact@bebsttropez.fr	<b>B&amp;B Italia Istanbul</b> Dereboyu Cd. No. 78, Ortaköy - Istanbul T. +90 212 327 0595 info@mozaikdesign.com	<b>B&amp;B Italia Chicago</b> 314 West Superior St. Chicago, IL 60654 T 312 335 3855 info@wpachicago.com	<b>B&amp;B Italia Belo Horizonte</b> Rua Andaluzita, 125 Carmo Sion Belo Horizonte (MG) T. +55 31 3281 4882 contato@casualmoveis.com.br
---	--	--	---

<b>B&amp;B Italia Lyon</b> 22 Rue Auguste Comte 69002 Lyon T. +33 09 86 56 21 53 bebitalia@maisonhomedesign.fr	<b>B&amp;B Italia Miami</b> 2331 Ponce de Leon Boulevard Coral Gables, FL 33134 T. 305 448 7367 info@luminaire.com	<b>B&amp;B Italia Dallas</b> 1707 Oak Lawn Avenue, Dallas, TX 75207 T. 214 389 9513 info@bebitalia.com	<b>B&amp;B Italia Shenzhen</b> No.109-209A North Zone, One Shenzhen Bay Plaza, Nanshan District, Shenzhen, Guangdong T. 400 823 8099 info@wanbinspace.com
--	--	--	---

<b>B&amp;B Italia Berlin</b> Torstrasse 140 10119 Berlin T. +49 30403 691020 info@minimum.de	<b>B&amp;B Italia Munich</b> Maximiliansplatz 21 80333 München T. 089 461 368 - 0 info@bebitalia.de	<b>B&amp;B Italia San Francisco</b> 2211 Alameda Street, San Francisco, CA 94103 T. 415 565 0900 sales@arksf.com	<b>B&amp;B Italia Hong Kong</b> 31st floor. China Online Center 333 Lockhart Road, Wanchai Hong Kong T. +852 2295 3612 bebitalia@colourliving.com
--	---	--	--

<b>B&amp;B Italia Tokyo</b> 1, 3F Aoyama OM- Square 2-5-8, Kita Aoyama, Minato-ku, Tokyo 107-0061 T. 03 3478 3837 info@bebitalia.co.jp	<b>B&amp;B Italia Beijing</b> No.5-1-03,1st Floor, International Hall, Easyhome, North 4th Ring Road, Chaoyang District, Beijing T. +86 10 84648161 beb@designspace.com.cn	<b>B&amp;B Italia Hangzhou</b> (opening October 2019) 523 Mahaprutharam Road 10500 Bangkok, Thailand T. +66 2 237 6999 badipol.ch@yipjacks.com	<b>B&amp;B Italia Bangkok</b> (opening October 2019) A10, GF, Derlook mall, N18 Xihu Avenue, Hangzhou
---	--	---	--

<b>B&amp;B Italia Shanghai</b> Unit L1-W10, No. 168 Hubin Rd., Huangpu District, Shanghai 200021 T. +86 021 63300606 info@arealiving.cn	<b>B&amp;B Italia Nanjing</b> No. 168, Jiangdongzhong Road, Jianye District, Nanjing, Jiangsu T. 025 6819 7311 info@yonglong-furniture.com	<b>B&amp;B Italia Ho Chi Minh City</b> 1st Floor Times Square Building 22-36 Nguyen Hue Boulevard & 57-69F Dong Khoi Street, Ben Nghe Ward, District 1, Ho Chi Minh City, Vietnam T. +84-8 66 840 333 bebitalia@eurasia-concept.com	<b>B&amp;B Italia Manila</b> Twenty-four Seven McKinley Corner of Seventh Avenue, 24th Street & McKinley Parkway, Bonifacio Global City Philippines T. +63 2 634 85 87 corporate@focusglobalinc.com
--	--	---	---



## Credits / Crediti

**Art direction  
and graphic design**  
Juma

**Photographer**  
Fabrizio Bergamo  
Federico Cedrone

**Styling**  
Simona Silenzi Studio  
With: Alessandra Chiarelli  
and Gaia Marchesini

**Pre-press**  
Adda Officine Grafiche

**Printing**  
Grafiche Antiga

**Copyright**  
CR&S B&B Italia  
September 2019

**Thanks to**  
10 A.M. ART, AYTM, Arcade  
Atipico, Azucena, Danyè Decoracion  
Flos, Galleria Bianconi, Ivano Redaelli,  
Lorenzo Franceschinis, Maddalena  
Selvini, Menhir Arte Contemporanea  
Nero Design Gallery, Osart Gallery  
Pascal Oudet, Tina Marie Copenhagen  
When Object Works,  
Wall finishing: Terrasilk by Matteo Brioni

**Works of art:**  
p.12, 14: Edgar Hofschen,  
*C 13/3*, Galleria Menhir, p. 21: Edgar  
Hofschen, *F 2/2*, Galleria Menhir,  
p.24,25: Paola Di Bello, *Medusa*,  
Galleria Bianconi, p. 47: Vincenzo  
Agnetti, *Almost forgotten by heart*  
(*Opera quasi dimenticata a memoria*),  
Osart, Gallery, p.23, 38, 70, 72: Sandro  
de Alexandris, *Porta*, 10 A.M. ART

Descriptions and pictures of products included  
in this catalogue have an indicative value only  
and are not binding for products' use.  
B&B Italia reserves the right to modify  
their products without prior notification.  
For further technical information of the products,  
please contact the authorised dealer closest  
to you (see [www.bebitalia.com](http://www.bebitalia.com)).

La descrizione e le immagini dei prodotti  
del presente catalogo sono puramente  
indicative e non possono essere considerate  
vincolati ai fini del loro utilizzo.  
B&B Italia si riserva di apportare ai prodotti  
le modifiche che ritiene più opportune,  
in qualsiasi momento e senza preavviso.  
Per ulteriori informazioni sulle caratteristiche  
tecniche dei prodotti, invitiamo a consultare  
il sito [www.bebitalia.com](http://www.bebitalia.com) dove troverete  
l'elenco dei rivenditori autorizzati a cui rivolgervi.

